

HIGHLIGHTS OF PRESCRIBING INFORMATION

These highlights do not include all the information needed to use EPCLUSA safely and effectively. See full prescribing information for EPCLUSA.

EPCLUSA® (sofosbuvir and velpatasvir) tablets, for oral use
EPCLUSA® (sofosbuvir and velpatasvir) oral pellets
Initial U.S. Approval: 2016

WARNING: RISK OF HEPATITIS B VIRUS REACTIVATION IN PATIENTS COINFECTED WITH HCV AND HBV

See full prescribing information for complete boxed warning.

Hepatitis B virus (HBV) reactivation has been reported, in some cases resulting in fulminant hepatitis, hepatic failure, and death. (5.1)

RECENT MAJOR CHANGES

Indications and Usage (1)	06/2021
Dosage and Administration	
Recommended Treatment Regimen and Duration in Patients 3 Years of Age and Older (2.2)	06/2021
Recommended Dosage in Pediatric Patients 3 Years of Age and Older (2.4)	06/2021
Preparation and Administration of Oral Pellets (2.5)	06/2021

INDICATIONS AND USAGE

EPCLUSA is a fixed-dose combination of sofosbuvir, a hepatitis C virus (HCV) nucleotide analog NS5B polymerase inhibitor, and velpatasvir, an HCV NS5A inhibitor, and is indicated for the treatment of adults and pediatric patients 3 years of age and older with chronic HCV genotype 1, 2, 3, 4, 5, or 6 infection (1):

- without cirrhosis or with compensated cirrhosis
- with decompensated cirrhosis for use in combination with ribavirin

DOSAGE AND ADMINISTRATION

- Testing prior to the initiation of therapy: Test all patients for HBV infection by measuring HBsAg and anti-HBc. (2.1)
- See recommended treatment regimen and duration in patients 3 years of age and older with genotypes 1, 2, 3, 4, 5, or 6 HCV in table below: (2.2)

Patient Population	Regimen and Duration
Treatment-naïve and treatment-experienced ^a , without cirrhosis and with compensated cirrhosis (Child-Pugh A)	EPCLUSA 12 weeks
Treatment-naïve and treatment-experienced ^a , with decompensated cirrhosis (Child-Pugh B and C)	EPCLUSA + ribavirin 12 weeks

a. In clinical trials, regimens contained peginterferon alfa/ribavirin with or without an HCV NS3/4A protease inhibitor (boceprevir, simeprevir, or telaprevir).

- Recommended dosage in adults: One tablet (400 mg of sofosbuvir and 100 mg of velpatasvir) taken orally once daily with or without food. (2.3)
- Recommended dosage in pediatric patients 3 years and older: Recommended dosage is based on weight. Refer to Table 2 of the full prescribing information for specific dosing guidelines based on body weight. (2.4)
- For pediatric patients less than 6 years of age, administer EPCLUSA oral pellets with food. (2.4)
- Instructions for Use should be followed for preparation and administration of EPCLUSA oral pellets. (2.5)
- HCV/HIV-1 coinfection: For patients with HCV/HIV-1 coinfection, follow the dosage recommendations in the table above. (2.2)
- For treatment-naïve and treatment-experienced liver transplant recipients without cirrhosis or with compensated cirrhosis (Child-

Pugh A), the recommended regimen is EPCLUSA once daily for 12 weeks. (2.2)

- If used in combination with ribavirin, follow the recommendations for ribavirin dosing and dosage modifications. (2.3, 2.4)
- For patients with renal impairment including end stage renal disease on dialysis, follow the dosage recommendations in the table above. (2.6)

DOSAGE FORMS AND STRENGTHS

- Tablets: 400 mg of sofosbuvir and 100 mg of velpatasvir; 200 mg of sofosbuvir and 50 mg of velpatasvir. (3)
- Oral Pellets: 200 mg of sofosbuvir and 50 mg of velpatasvir; 150 mg of sofosbuvir and 37.5 mg of velpatasvir. (3)

CONTRAINDICATIONS

EPCLUSA and ribavirin combination regimen is contraindicated in patients for whom ribavirin is contraindicated. (4)

WARNINGS AND PRECAUTIONS

- Risk of Hepatitis B Virus Reactivation: Test all patients for evidence of current or prior HBV infection before initiation of HCV treatment. Monitor HCV/HBV coinfecting patients for HBV reactivation and hepatitis flare during HCV treatment and post-treatment follow-up. Initiate appropriate patient management for HBV infection as clinically indicated. (5.1)
- Bradycardia with amiodarone coadministration: Serious symptomatic bradycardia may occur in patients taking amiodarone, particularly in patients also receiving beta blockers, or those with underlying cardiac comorbidities and/or advanced liver disease. Coadministration of amiodarone with EPCLUSA is not recommended. In patients without alternative viable treatment options, cardiac monitoring is recommended. (5.2, 7.3)

ADVERSE REACTIONS

- The most common adverse reactions (incidence greater than or equal to 10%, all grades) observed in adults and pediatric subjects 6 years of age and older with treatment with EPCLUSA for 12 weeks are headache and fatigue. (6.1)
- The most common adverse reactions (incidence greater than or equal to 10%, grade 1 or 2) observed in pediatric subjects less than 6 years of age are vomiting and product use issue (spitting up the drug). (6.1)
- The most common adverse reactions (incidence greater than or equal to 10%, all grades) observed with treatment with EPCLUSA and ribavirin for 12 weeks in adult patients with decompensated cirrhosis are fatigue, anemia, nausea, headache, insomnia, and diarrhea. (6.1)

To report SUSPECTED ADVERSE REACTIONS, contact Gilead Sciences, Inc. at 1-800-GILEAD-5 or FDA at 1-800-FDA-1088 or www.fda.gov/medwatch.

DRUG INTERACTIONS

- P-gp inducers and/or moderate to strong CYP inducers (e.g., rifampin, St. John's wort, carbamazepine): May decrease concentrations of sofosbuvir and/or velpatasvir. Use of EPCLUSA with P-gp inducers and/or moderate to strong CYP inducers is not recommended. (5.3, 7)
- Consult the full prescribing information prior to use for potential drug interactions. (5.2, 5.3, 7)
- Clearance of HCV infection with direct acting antivirals may lead to changes in hepatic function, which may impact safe and effective use of concomitant medications. Frequent monitoring of relevant laboratory parameters (INR or blood glucose) and dose adjustments of certain concomitant medications may be necessary. (7.3)

See 17 for PATIENT COUNSELING INFORMATION and FDA-approved patient labeling.

Revised: 06/2021

FULL PRESCRIBING INFORMATION: CONTENTS*

WARNING: RISK OF HEPATITIS B VIRUS REACTIVATION IN PATIENTS COINFECTED WITH HCV AND HBV

1 INDICATIONS AND USAGE

2 DOSAGE AND ADMINISTRATION

- 2.1 Testing Prior to the Initiation of Therapy
- 2.2 Recommended Treatment Regimen and Duration in Patients 3 Years of Age and Older
- 2.3 Recommended Dosage in Adults
- 2.4 Recommended Dosage in Pediatric Patients 3 Years of Age and Older
- 2.5 Preparation and Administration of Oral Pellets
- 2.6 Renal Impairment

3 DOSAGE FORMS AND STRENGTHS

4 CONTRAINDICATIONS

5 WARNINGS AND PRECAUTIONS

- 5.1 Risk of Hepatitis B Virus Reactivation in Patients Coinfected with HCV and HBV
- 5.2 Serious Symptomatic Bradycardia When Coadministered with Amiodarone
- 5.3 Risk of Reduced Therapeutic Effect Due to Concomitant Use of EPCLUSA with Inducers of P-gp and/or Moderate to Strong Inducers of CYP
- 5.4 Risks Associated with Ribavirin and EPCLUSA Combination Treatment

6 ADVERSE REACTIONS

- 6.1 Clinical Trials Experience
- 6.2 Postmarketing Experience

7 DRUG INTERACTIONS

- 7.1 Potential for Other Drugs to Affect EPCLUSA
- 7.2 Potential for EPCLUSA to Affect Other Drugs
- 7.3 Established and Potentially Significant Drug Interactions

- 7.4 Drugs without Clinically Significant Interactions with EPCLUSA

8 USE IN SPECIFIC POPULATIONS

- 8.1 Pregnancy
- 8.2 Lactation
- 8.3 Females and Males of Reproductive Potential
- 8.4 Pediatric Use
- 8.5 Geriatric Use
- 8.6 Renal Impairment
- 8.7 Hepatic Impairment

10 OVERDOSAGE

11 DESCRIPTION

12 CLINICAL PHARMACOLOGY

- 12.1 Mechanism of Action
- 12.2 Pharmacodynamics
- 12.3 Pharmacokinetics
- 12.4 Microbiology

13 NONCLINICAL TOXICOLOGY

- 13.1 Carcinogenesis, Mutagenesis, Impairment of Fertility

14 CLINICAL STUDIES

- 14.1 Description of Clinical Trials
- 14.2 Clinical Trials in Subjects without Cirrhosis and Subjects with Compensated Cirrhosis
- 14.3 Clinical Trial in Subjects Coinfected with HCV and HIV-1
- 14.4 Clinical Trials in Subjects with Decompensated Cirrhosis
- 14.5 Clinical Trial in Adult Liver Transplant Recipients without Cirrhosis and with Compensated Cirrhosis
- 14.6 Clinical Trial in Subjects with Severe Renal Impairment Requiring Dialysis
- 14.7 Clinical Trial in Pediatric Subjects

16 HOW SUPPLIED/STORAGE AND HANDLING

17 PATIENT COUNSELING INFORMATION

* Sections or subsections omitted from the full prescribing information are not listed.

FULL PRESCRIBING INFORMATION

WARNING: RISK OF HEPATITIS B VIRUS REACTIVATION IN PATIENTS COINFECTED WITH HCV AND HBV

Test all patients for evidence of current or prior hepatitis B virus (HBV) infection before initiating treatment with EPCLUSA. HBV reactivation has been reported in HCV/HBV coinfecting patients who were undergoing or had completed treatment with HCV direct acting antivirals and were not receiving HBV antiviral therapy. Some cases have resulted in fulminant hepatitis, hepatic failure, and death. Monitor HCV/HBV coinfecting patients for hepatitis flare or HBV reactivation during HCV treatment and post-treatment follow-up. Initiate appropriate patient management for HBV infection as clinically indicated [see *Warnings and Precautions (5.1)*].

1 INDICATIONS AND USAGE

EPCLUSA is indicated for the treatment of adults and pediatric patients 3 years of age and older with chronic hepatitis C virus (HCV) genotype 1, 2, 3, 4, 5, or 6 infection [see *Dosage and Administration (2.2, 2.3, 2.4)* and *Clinical Studies (14)*]:

- without cirrhosis or with compensated cirrhosis
- with decompensated cirrhosis for use in combination with ribavirin.

2 DOSAGE AND ADMINISTRATION

2.1 Testing Prior to the Initiation of Therapy

Test all patients for evidence of current or prior HBV infection by measuring hepatitis B surface antigen (HBsAg) and hepatitis B core antibody (anti-HBc) before initiating HCV treatment with EPCLUSA [see *Warnings and Precautions (5.1)*].

2.2 Recommended Treatment Regimen and Duration in Patients 3 Years of Age and Older

Table 1 shows the recommended treatment regimen and duration based on patient population.

For patients with HCV/HIV-1 coinfection, follow the dosage recommendations in Table 1. For treatment-naïve and treatment-experienced liver transplant recipients without cirrhosis or with compensated cirrhosis (Child-Pugh A), the recommended regimen is EPCLUSA once daily for 12 weeks [see *Clinical Studies (14.3 and 14.5)*]. Refer to *Drug Interactions (7)* for dosage recommendations for concomitant drugs.

Table 1 Recommended Treatment Regimen and Duration in Patients 3 Years of Age and Older with Genotype 1, 2, 3, 4, 5, or 6 HCV

Patient Population	Treatment Regimen and Duration
Treatment-naïve and treatment-experienced ^a , without cirrhosis and with compensated cirrhosis (Child-Pugh A)	EPCLUSA 12 weeks
Treatment-naïve and treatment-experienced ^a , with decompensated cirrhosis (Child-Pugh B or C)	EPCLUSA + ribavirin ^b 12 weeks

a. In clinical trials in adults, regimens contained peginterferon alfa/ribavirin with or without an HCV NS3/4A protease inhibitor (boceprevir, simeprevir, or telaprevir).

b. See Dosage and Administration 2.3 and 2.4 for ribavirin dosage recommendations.

2.3 Recommended Dosage in Adults

The recommended dosage of EPCLUSA in adults is one tablet (400 mg sofosbuvir and 100 mg velpatasvir) taken orally once daily with or without food [see *Clinical Pharmacology* (12.3)].

When administered with EPCLUSA, the recommended dosage of ribavirin is based on weight (administered with food): 1,000 mg per day for patients less than 75 kg and 1,200 mg for those weighing at least 75 kg, divided and administered twice daily. The starting dosage and on-treatment dosage of ribavirin can be decreased based on hemoglobin and creatinine clearance. For ribavirin dosage modifications refer to the ribavirin prescribing information [see *Use in Specific Populations* (8.6) and *Clinical Studies* (14.4)].

2.4 Recommended Dosage in Pediatric Patients 3 Years of Age and Older

The recommended dosage of EPCLUSA in pediatric patients 3 years of age and older is based on weight and provided in Table 2. Table 3 provides the weight-based dosage of ribavirin when used in combination with EPCLUSA for pediatric patients. Take EPCLUSA oral pellets or tablets once daily with or without food. In pediatric patients less than 6 years of age, administer the oral pellets with food to increase tolerability related to palatability [see *Use in Specific Populations* (8.4), *Clinical Pharmacology* (12.3), and *Clinical Studies* (14.7)].

Table 2 Dosing for Pediatric Patients 3 Years and Older with Genotype 1, 2, 3, 4, 5, or 6 HCV Using EPCLUSA Oral Pellets or Tablets

Body Weight (kg)	EPCLUSA Daily Dose	Dosing of EPCLUSA Oral Pellets	Dosing of EPCLUSA Tablet
less than 17	150 mg/37.5 mg per day	one 150 mg/37.5 mg packet of pellets once daily	N/A
17 to less than 30	200 mg/50 mg per day	one 200 mg/50 mg packet of pellets once daily	one 200 mg/50 mg tablet once daily
at least 30	400 mg/100 mg per day	two 200 mg/50 mg packets of pellets once daily	one 400 mg/100 mg tablet once daily ^a

a. Two 200 mg/50 mg tablets once daily can be used for patients who cannot swallow the 400 mg/100 mg tablet.

Table 3 Recommended Dosing for Ribavirin in Combination Therapy with EPCLUSA for Pediatric Patients 3 Years and Older

Body Weight (kg)	Oral Ribavirin Daily Dosage ^a
less than 47	15 mg per kg per day (divided dose AM and PM)
47–49	600 mg per day (1 x 200 mg AM, 2 x 200 mg PM)
50–65	800 mg per day (2 x 200 mg AM, 2 x 200 mg PM)
66–80	1,000 mg per day (2 x 200 mg AM, 3 x 200 mg PM)
greater than 80	1,200 mg per day (3 x 200 mg AM, 3 x 200 mg PM)

a. The daily dosage of ribavirin is weight-based and is administered orally in two divided doses with food.

2.5 Preparation and Administration of Oral Pellets

See the EPCLUSA oral pellets full Instructions for Use for details on the preparation and administration of EPCLUSA oral pellets.

Do not chew EPCLUSA oral pellets to avoid a bitter aftertaste. EPCLUSA oral pellets can be taken directly in the mouth or with food (See Instructions for Use). In pediatric patients less than 6 years of age, administer the oral pellets with food to increase tolerability related to palatability. Sprinkle the oral pellets on one or more spoonfuls of non-acidic soft food at or below room temperature. Examples of non-acidic foods include pudding, chocolate syrup, and ice cream. Take EPCLUSA oral pellets within 15 minutes of gently mixing with food and swallow the entire contents without chewing.

2.6 Renal Impairment

No dosage adjustment of EPCLUSA is recommended in patients with any degree of renal impairment, including patients requiring dialysis. Administer EPCLUSA with or without ribavirin according to the recommendations in Table 1 [see *Adverse Reactions (6.1)*, *Use in Specific Populations (8.6)*, and *Clinical Studies (14.6)*]. Refer to ribavirin tablet prescribing information for ribavirin dosage modification for patients with CrCl less than or equal to 50 mL per minute.

3 DOSAGE FORMS AND STRENGTHS

EPCLUSA is available as tablets or pellets for oral use. Each dosage form is available in two dose strengths:

- 400 mg/100 mg Tablets: pink, diamond-shaped, film-coated tablet debossed with “GSI” on one side and “7916” on the other side. Each tablet contains 400 mg of sofosbuvir and 100 mg of velpatasvir.
- 200 mg/50 mg Tablets: pink, oval-shaped, film-coated tablet debossed with “GSI” on one side and “S/V” on the other side. Each tablet contains 200 mg of sofosbuvir and 50 mg of velpatasvir.
- 200 mg/50 mg Oral Pellets: white to off-white, film-coated pellets in unit-dose packets. Each packet contains 200 mg of sofosbuvir and 50 mg of velpatasvir.
- 150 mg/37.5 mg Oral Pellets: white to off-white, film-coated pellets in unit-dose packets. Each packet contains 150 mg of sofosbuvir and 37.5 mg of velpatasvir.

4 CONTRAINDICATIONS

EPCLUSA and ribavirin combination regimen is contraindicated in patients for whom ribavirin is contraindicated. Refer to the ribavirin prescribing information for a list of contraindications for ribavirin [see *Dosage and Administration (2.2, 2.3, 2.4)*].

5 WARNINGS AND PRECAUTIONS

5.1 Risk of Hepatitis B Virus Reactivation in Patients Coinfected with HCV and HBV

Hepatitis B virus (HBV) reactivation has been reported in HCV/HBV coinfecting patients who were undergoing or had completed treatment with HCV direct acting antivirals, and who were not receiving HBV antiviral therapy. Some cases have resulted in fulminant hepatitis, hepatic failure, and death. Cases have been reported in patients who are HBsAg positive and also in patients with serologic evidence of resolved HBV infection (i.e., HBsAg negative and anti-HBc positive). HBV reactivation has also been reported in patients receiving certain immunosuppressants or chemotherapeutic agents; the risk of HBV reactivation associated with treatment with HCV direct-acting antivirals may be increased in these patients.

HBV reactivation is characterized as an abrupt increase in HBV replication manifesting as a rapid increase in serum HBV DNA level. In patients with resolved HBV infection, reappearance of HBsAg can occur. Reactivation of HBV replication may be accompanied by hepatitis, i.e., increases in aminotransferase levels and, in severe cases, increases in bilirubin levels, liver failure, and death can occur.

Test all patients for evidence of current or prior HBV infection by measuring HBsAg and anti-HBc before initiating HCV treatment with EPCLUSA. In patients with serologic evidence of HBV infection, monitor for clinical and laboratory signs of hepatitis flare or HBV reactivation during HCV treatment with EPCLUSA and during post-treatment follow-up. Initiate appropriate patient management for HBV infection as clinically indicated.

5.2 Serious Symptomatic Bradycardia When Coadministered with Amiodarone

Postmarketing cases of symptomatic bradycardia and cases requiring pacemaker intervention have been reported when amiodarone is coadministered with a sofosbuvir-containing regimen. A fatal cardiac arrest was reported in a patient taking amiodarone who was coadministered a sofosbuvir-containing regimen (HARVONI[®] [ledipasvir/sofosbuvir]). Bradycardia has generally occurred within hours to days, but cases have been observed up to 2 weeks after initiating HCV treatment. Patients also taking beta blockers, or those with underlying cardiac comorbidities and/or advanced liver disease may be at increased risk for symptomatic bradycardia with coadministration of amiodarone. Bradycardia generally resolved after discontinuation of HCV treatment. The mechanism for this effect is unknown.

Coadministration of amiodarone with EPCLUSA is not recommended. For patients taking amiodarone who have no other alternative viable treatment options and who will be coadministered EPCLUSA:

- Counsel patients about the risk of symptomatic bradycardia.

- Cardiac monitoring in an in-patient setting for the first 48 hours of coadministration is recommended, after which outpatient or self-monitoring of the heart rate should occur on a daily basis through at least the first 2 weeks of treatment.

Patients who are taking EPCLUSA who need to start amiodarone therapy due to no other alternative viable treatment options should undergo similar cardiac monitoring as outlined above.

Due to amiodarone's long half-life, patients discontinuing amiodarone just prior to starting EPCLUSA should also undergo similar cardiac monitoring as outlined above.

Patients who develop signs or symptoms of bradycardia should seek medical evaluation immediately. Symptoms may include near-fainting or fainting, dizziness or lightheadedness, malaise, weakness, excessive tiredness, shortness of breath, chest pains, confusion, or memory problems [see *Adverse Reactions (6.2) and Drug Interactions (7.3)*].

5.3 Risk of Reduced Therapeutic Effect Due to Concomitant Use of EPCLUSA with Inducers of P-gp and/or Moderate to Strong Inducers of CYP

Drugs that are inducers of P-gp and/or moderate to strong inducers of CYP2B6, CYP2C8, or CYP3A4 (e.g., rifampin, St. John's wort, carbamazepine) may significantly decrease plasma concentrations of sofosbuvir and/or velpatasvir, leading to potentially reduced therapeutic effect of EPCLUSA. The use of these agents with EPCLUSA is not recommended [see *Drug Interactions (7.3)*].

5.4 Risks Associated with Ribavirin and EPCLUSA Combination Treatment

If EPCLUSA is administered with ribavirin, the warnings and precautions for ribavirin apply to this combination regimen. Refer to the ribavirin prescribing information for a full list of the warnings and precautions for ribavirin [see *Dosage and Administration (2.2)*].

6 ADVERSE REACTIONS

The following serious adverse reactions are described below and elsewhere in labeling:

- Serious Symptomatic Bradycardia When Coadministered with Amiodarone [see *Warnings and Precautions (5.2)*].

6.1 Clinical Trials Experience

Because clinical trials are conducted under widely varying conditions, adverse reaction rates observed in the clinical trials of a drug cannot be directly compared to rates in the clinical trials of another drug and may not reflect the rates observed in practice.

If EPCLUSA is administered with ribavirin, refer to the prescribing information for ribavirin for a description of ribavirin-associated adverse reactions.

Clinical Trials in Adult Subjects

Adverse Reactions in Subjects without Cirrhosis or with Compensated Cirrhosis

The adverse reactions data for EPCLUSA in patients without cirrhosis or with compensated cirrhosis were derived from three Phase 3 clinical trials (ASTRAL-1, ASTRAL-2, and ASTRAL-3) which evaluated a total of 1035 subjects infected with genotype 1, 2, 3, 4, 5, or 6 HCV, without cirrhosis or with compensated cirrhosis, who

received EPCLUSA for 12 weeks. EPCLUSA was studied in placebo- and active-controlled trials [see *Clinical Studies (14.2)*].

The proportion of subjects who permanently discontinued treatment due to adverse events was 0.2% for subjects who received EPCLUSA for 12 weeks.

The most common adverse reactions (adverse events assessed as causally related by the investigator and at least 10%) were headache and fatigue in subjects treated with EPCLUSA for 12 weeks.

Adverse reactions, all grades, observed in greater than or equal to 5% of subjects receiving 12 weeks of treatment with EPCLUSA in ASTRAL-1 include headache (22%), fatigue (15%), nausea (9%), asthenia (5%), and insomnia (5%). Of subjects receiving EPCLUSA who experienced these adverse reactions, 79% had an adverse reaction of mild severity (Grade 1). With the exception of asthenia, each of these adverse reactions occurred at a similar frequency or more frequently in subjects treated with placebo compared to subjects treated with EPCLUSA (asthenia: 3% versus 5% for the placebo and EPCLUSA groups, respectively).

The adverse reactions observed in subjects treated with EPCLUSA in ASTRAL-2 and ASTRAL-3 were consistent with those observed in ASTRAL-1. Irritability was also observed in greater than or equal to 5% of subjects treated with EPCLUSA in ASTRAL-3.

Adverse Reactions in Subjects Coinfected with HCV and HIV-1

The safety assessment of EPCLUSA in subjects with HCV/HIV-1 coinfection was based on an open-label clinical trial (ASTRAL-5) in 106 subjects who were on stable antiretroviral therapy [see *Clinical Studies (14.3)*]. The safety profile in HCV/HIV-1 coinfecting subjects was similar to that observed in HCV mono-infected subjects. The most common adverse reactions occurring in at least 10% of subjects were fatigue (22%) and headache (10%).

Adverse Reactions in Subjects with Decompensated Cirrhosis

The safety assessment of EPCLUSA in subjects infected with genotype 1, 2, 3, 4, or 6 HCV with decompensated cirrhosis was based on one Phase 3 trial (ASTRAL-4) including 87 subjects who received EPCLUSA with ribavirin for 12 weeks. All 87 subjects had Child-Pugh B cirrhosis at screening. On the first day of treatment with EPCLUSA with ribavirin, 6 subjects and 4 subjects were assessed to have Child-Pugh A and Child-Pugh C cirrhosis, respectively [see *Clinical Studies (14.4)*].

The most common adverse reactions (adverse events assessed as causally related by the investigator, all grades with frequency of 10% or greater) in the 87 subjects who received EPCLUSA with ribavirin for 12 weeks were fatigue (32%), anemia (26%), nausea (15%), headache (11%), insomnia (11%), and diarrhea (10%). Of subjects who experienced these adverse reactions, 98% had adverse reactions of mild to moderate severity.

A total of 4 (5%) subjects permanently discontinued EPCLUSA with ribavirin due to an adverse event; there was no adverse event leading to discontinuation that occurred in more than 1 subject.

Decreases in hemoglobin to less than 10 g/dL and 8.5 g/dL during treatment were observed in 23% and 7% of subjects treated with EPCLUSA with ribavirin for 12 weeks, respectively. Ribavirin was permanently discontinued in 17% of subjects treated with EPCLUSA with ribavirin for 12 weeks, due to adverse reactions.

Less Common Adverse Reactions Reported in Clinical Trials

The following adverse reactions occurred in less than 5% of subjects without cirrhosis or with compensated cirrhosis treated with EPCLUSA for 12 weeks and are included because of a potential causal relationship.

Rash: In the ASTRAL-1 study, rash occurred in 2% of subjects treated with EPCLUSA and in 1% of subjects treated with placebo. No serious adverse reactions of rash occurred, and all rashes were mild or moderate in severity.

Depression: In the ASTRAL-1 study, depressed mood occurred in 1% of subjects treated with EPCLUSA and was not reported by any subject taking placebo. No serious adverse reactions of depressed mood occurred, and all events were mild or moderate in severity.

The following adverse reactions occurred in less than 10% of subjects with decompensated cirrhosis (ASTRAL-4) treated with EPCLUSA with ribavirin for 12 weeks and are included because of a potential causal relationship.

Rash: Rash occurred in 5% of subjects treated with EPCLUSA with ribavirin. No serious adverse reactions of rash occurred, and all rashes were mild or moderate in severity.

Laboratory Abnormalities

Lipase Elevations: In ASTRAL-1, isolated, asymptomatic lipase elevations of greater than 3xULN were observed in 3% and 1% of subjects treated with EPCLUSA and placebo for 12 weeks, respectively; and in 6% and 3% of subjects treated with EPCLUSA in ASTRAL-2 and ASTRAL-3, respectively.

In the Phase 3 trial of subjects with decompensated cirrhosis (ASTRAL-4), lipase was assessed when amylase values were greater than or equal to 1.5xULN. Isolated, asymptomatic lipase elevations of greater than 3xULN were observed in 2% of subjects treated with EPCLUSA with ribavirin for 12 weeks.

Creatine Kinase: In ASTRAL-1, isolated, asymptomatic creatine kinase elevations greater than or equal to 10xULN were reported in 1% and 0% of subjects treated with EPCLUSA and placebo for 12 weeks, respectively; and in 2% and 1% of subjects treated with EPCLUSA in ASTRAL-2 and ASTRAL-3, respectively.

In the Phase 3 trial with decompensated cirrhosis (ASTRAL-4), isolated, asymptomatic creatine kinase elevations greater than or equal to 10xULN were reported in 1% of subjects treated with EPCLUSA with ribavirin for 12 weeks.

Indirect Bilirubin: Increases in indirect bilirubin up to 3 mg/dL above baseline were noted among HIV-1/HCV coinfecting subjects treated with EPCLUSA and an

atazanavir/ritonavir-based antiretroviral regimen. The elevated indirect bilirubin values were not associated with clinical adverse events, and all subjects completed 12 weeks of EPCLUSA without dose adjustment or treatment interruption of either EPCLUSA or HIV antiretroviral agents.

Adverse Reactions in Adult Liver Transplant Recipients

The safety assessment of EPCLUSA in liver transplant recipients was based on an open-label clinical trial (Trial 2104) in 79 adults without cirrhosis or with compensated cirrhosis who received EPCLUSA for 12 weeks [see *Clinical Studies (14.5)*]. One subject discontinued treatment due to an adverse event on Day 7. The adverse reactions observed were consistent with the known safety profile of EPCLUSA. Adverse reactions occurring in at least 5% of subjects were headache (18%), fatigue (15%), nausea (8%), diarrhea (6%), and asthenia (5%).

Adverse Reactions in Adults with Severe Renal Impairment Requiring Dialysis

In an open-label trial (Trial 4062), in which a total of 59 adults with HCV with compensated liver disease (with or without cirrhosis) and ESRD requiring dialysis received EPCLUSA for 12 weeks, the most common adverse reaction was nausea (7%) [see *Clinical Studies (14.6)*].

Adverse Reactions in Pediatric Subjects 3 Years of Age and Older

The safety assessment of EPCLUSA in pediatric subjects 3 years of age and older is based on data from a Phase 2, open-label clinical trial (Study 1143) that enrolled 216 subjects who were treated with EPCLUSA for 12 weeks [see *Clinical Studies (14.7)*]. The adverse reactions observed in pediatric subjects 6 years of age and older were consistent with those observed in clinical trials of EPCLUSA in adults.

Among the 41 pediatric subjects less than 6 years of age, gastrointestinal adverse reactions were reported more commonly compared to subjects 6 years of age and older. Vomiting and product use issue (spitting up the drug) were reported in 15% and 10% of subjects, respectively; these adverse reactions were mild (Grade 1 or 2) and led to treatment discontinuation in 5 (12%) subjects [see *Use in Specific Populations (8.4) and Clinical Studies (14.7)*].

6.2 Postmarketing Experience

The following adverse reactions have been identified during post approval use of sofosbuvir. Because postmarketing reactions are reported voluntarily from a population of uncertain size, it is not always possible to reliably estimate their frequency or establish a causal relationship to drug exposure.

Cardiac Disorders

Serious symptomatic bradycardia has been reported in patients taking amiodarone who initiate treatment with a sofosbuvir-containing regimen [see *Warnings and Precautions (5.2) and Drug Interactions (7.3)*].

Skin and Subcutaneous Tissue Disorders

Skin rashes, sometimes with blisters or angioedema-like swelling
Angioedema

7 DRUG INTERACTIONS

7.1 Potential for Other Drugs to Affect EPCLUSA

Sofosbuvir and velpatasvir are substrates of drug transporters P-gp and BCRP while GS-331007 (the predominant circulating metabolite of sofosbuvir) is not. In vitro, slow metabolic turnover of velpatasvir by CYP2B6, CYP2C8, and CYP3A4 was observed.

Drugs that are inducers of P-gp and/or moderate to strong inducers of CYP2B6, CYP2C8, or CYP3A4 (e.g., rifampin, St. John's wort, carbamazepine) may decrease plasma concentrations of sofosbuvir and/or velpatasvir, leading to reduced therapeutic effect of EPCLUSA. The use of these agents with EPCLUSA is not recommended [see *Warnings and Precautions (5.3) and Clinical Pharmacology (12.3)*]. EPCLUSA may be coadministered with P-gp, BCRP, and CYP inhibitors.

7.2 Potential for EPCLUSA to Affect Other Drugs

Velpatasvir is an inhibitor of drug transporters P-gp, breast cancer resistance protein (BCRP), OATP1B1, OATP1B3, and OATP2B1. Coadministration of EPCLUSA with drugs that are substrates of these transporters may increase the exposure of such drugs.

7.3 Established and Potentially Significant Drug Interactions

Clearance of HCV infection with direct acting antivirals may lead to changes in hepatic function, which may impact the safe and effective use of concomitant medications. For example, altered blood glucose control resulting in serious symptomatic hypoglycemia has been reported in diabetic patients in postmarketing case reports and published epidemiological studies. Management of hypoglycemia in these cases required either discontinuation or dose modification of concomitant medications used for diabetes treatment.

Frequent monitoring of relevant laboratory parameters (e.g., International Normalized Ratio [INR] in patients taking warfarin, blood glucose levels in diabetic patients) or drug concentrations of concomitant medications such as cytochrome P450 substrates with a narrow therapeutic index (e.g., certain immunosuppressants) is recommended to ensure safe and effective use. Dose adjustments of concomitant medications may be necessary.

Table 4 provides a listing of established or potentially clinically significant drug interactions. The drug interactions described are based on studies conducted with either EPCLUSA, the components of EPCLUSA (sofosbuvir and velpatasvir) as individual agents, or are predicted drug interactions that may occur with EPCLUSA [see *Warnings and Precautions (5.2, 5.3) and Clinical Pharmacology (12.3)*].

Table 4 Potentially Significant Drug Interactions: Alteration in Dose or Regimen May Be Recommended Based on Drug Interaction Studies or Predicted Interaction^a

Concomitant Drug Class: Drug Name	Effect on Concentration ^b	Clinical Effect/Recommendation
Acid Reducing Agents:	↓ velpatasvir	Velpatasvir solubility decreases as pH increases. Drugs that increase gastric pH are expected to decrease concentration of velpatasvir.
Antacids (e.g., aluminum and magnesium hydroxide)		Separate antacid and EPCLUSA administration by 4 hours.
H ₂ -receptor antagonists ^c (e.g., famotidine)		H ₂ -receptor antagonists may be administered simultaneously with or 12 hours apart from EPCLUSA at a dose that does not exceed doses comparable to famotidine 40 mg twice daily.
Proton-pump inhibitors ^c (e.g., omeprazole)		Coadministration of omeprazole or other proton-pump inhibitors is not recommended. If it is considered medically necessary to coadminister, EPCLUSA should be administered with food and taken 4 hours before omeprazole 20 mg. Use with other proton-pump inhibitors has not been studied.
Antiarrhythmics: amiodarone	Effect on amiodarone, sofosbuvir, and velpatasvir concentrations unknown	Coadministration of amiodarone with a sofosbuvir-containing regimen may result in serious symptomatic bradycardia. The mechanism of this effect is unknown. Coadministration of amiodarone with EPCLUSA is not recommended; if coadministration is required, cardiac monitoring is recommended [see <i>Warnings and Precautions (5.2) and Adverse Reactions (6.2)</i>].
digoxin ^c	↑ digoxin	Therapeutic concentration monitoring of digoxin is recommended when coadministered with EPCLUSA. Refer to digoxin prescribing information for monitoring and dose modification recommendations for concentration increases of less than 50%.
Anticancers: topotecan	↑ topotecan	Coadministration is not recommended.
Anticonvulsants: carbamazepine ^c phenytoin phenobarbital	↓ sofosbuvir ↓ velpatasvir	Coadministration is not recommended.
Antimycobacterials: rifabutin ^c rifampin ^c rifapentine	↓ sofosbuvir ↓ velpatasvir	Coadministration is not recommended.
HIV Antiretrovirals: efavirenz ^c	↓ velpatasvir	Coadministration of EPCLUSA with efavirenz-containing regimens is not recommended.
Regimens containing tenofovir DF	↑ tenofovir	Monitor for tenofovir-associated adverse reactions in patients receiving EPCLUSA concomitantly with a regimen containing tenofovir DF. Refer to the prescribing information of the tenofovir DF-containing product for recommendations on renal monitoring.
tipranavir/ritonavir	↓ sofosbuvir ↓ velpatasvir	Coadministration is not recommended.
Herbal Supplements: St. John's wort (<i>Hypericum perforatum</i>)	↓ sofosbuvir ↓ velpatasvir	Coadministration is not recommended.

Concomitant Drug Class: Drug Name	Effect on Concentration ^b	Clinical Effect/Recommendation
HMG-CoA Reductase Inhibitors: rosuvastatin ^c	↑ rosuvastatin	Coadministration of EPCLUSA with rosuvastatin may significantly increase the concentration of rosuvastatin, which is associated with increased risk of myopathy, including rhabdomyolysis. Rosuvastatin may be administered with EPCLUSA at a dose that does not exceed 10 mg.
atorvastatin ^c	↑ atorvastatin	Coadministration of EPCLUSA with atorvastatin may be associated with increased risk of myopathy, including rhabdomyolysis. Monitor closely for HMG-CoA reductase inhibitor-associated adverse reactions, such as myopathy and rhabdomyolysis.

DF = disoproxil fumarate.

a. This table is not all inclusive.

b. ↓ = decrease, ↑ = increase.

c. These interactions have been studied in healthy adults.

7.4 Drugs without Clinically Significant Interactions with EPCLUSA

Based on drug interaction studies conducted with the components of EPCLUSA (sofosbuvir or velpatasvir) or EPCLUSA, no clinically significant drug interactions have been observed with the following drugs [see *Clinical Pharmacology (12.3)*]:

- EPCLUSA: atazanavir/ritonavir, cyclosporine, darunavir/ritonavir, dolutegravir, elvitegravir/cobicistat/emtricitabine/tenofovir alafenamide, emtricitabine, raltegravir, or rilpivirine.
- Sofosbuvir: ethinyl estradiol/norgestimate, methadone, or tacrolimus.
- Velpatasvir: ethinyl estradiol/norgestimate, ketoconazole, or pravastatin.

See Table 4 for use of EPCLUSA with certain HIV antiretroviral regimens [see *Drug Interactions (7.3)*].

8 USE IN SPECIFIC POPULATIONS

8.1 Pregnancy

Risk Summary

If EPCLUSA is administered with ribavirin, the combination regimen is contraindicated in pregnant women and in men whose female partners are pregnant. Refer to the ribavirin prescribing information for more information on ribavirin-associated risks of use during pregnancy.

No adequate human data are available to establish whether or not EPCLUSA poses a risk to pregnancy outcomes. In animal reproduction studies, no evidence of adverse developmental outcomes was observed with the components of EPCLUSA (sofosbuvir or velpatasvir) at exposures greater than those in humans at the recommended human dose (RHD) [see *Data*]. During organogenesis in the mouse, rat, and rabbit, systemic exposures (AUC) to velpatasvir were approximately 31 (mice), 6 (rats), and 0.4 (rabbits) times the exposure in humans at the RHD, while exposures to the predominant circulating metabolite of sofosbuvir (GS-331007) were approximately 4 (rats) and 10 (rabbits) times the exposure in humans at the RHD. In rat pre/postnatal development studies, maternal systemic exposures (AUC) to velpatasvir and GS-331007 were approximately 5 times the exposures of each component in humans at the RHD.

The background risk of major birth defects and miscarriage for the indicated population is unknown. In the U.S. general population, the estimated background risk of major birth defects and miscarriage in clinically recognized pregnancies is 2–4% and 15–20%, respectively.

Data

Sofosbuvir: Sofosbuvir was administered orally to pregnant rats (up to 500 mg/kg/day) and rabbits (up to 300 mg/kg/day) on gestation days 6 to 18 and 6 to 19, respectively, and also to rats (oral doses up to 500 mg/kg/day) on gestation day 6 to lactation/post-partum day 20. No significant effects on embryo-fetal (rats and rabbits) or pre/postnatal (rats) development were observed at the highest doses tested. The systemic exposures (AUC) of the predominant circulating metabolite of sofosbuvir (GS-331007) during gestation were approximately 4 (rats) and 10 (rabbits) times the exposure in humans at the RHD.

Velpatasvir: Velpatasvir was administered orally to pregnant mice (up to 1000 mg/kg/day), rats (up to 200 mg/kg/day), and rabbits (up to 300 mg/kg/day) on gestation days 6 to 15, 6 to 17, and 7 to 20, respectively, and also to rats (oral doses up to 200 mg/kg) on gestation day 6 to lactation/post-partum day 20. No significant effects on embryo-fetal (mice, rats, and rabbits) or pre/postnatal (rats) development were observed at the highest doses tested. The systemic exposures (AUC) of velpatasvir during gestation were approximately 31 (mice), 6 (rats), and 0.4 (rabbits) times the exposure in humans at the RHD.

8.2 Lactation

Risk Summary

It is not known whether the components of EPCLUSA and its metabolites are present in human breast milk, affect human milk production, or have effects on the breastfed infant. The predominant circulating metabolite of sofosbuvir (GS-331007) was the primary component observed in the milk of lactating rats administered sofosbuvir, without effect on nursing pups. When administered to lactating rats, velpatasvir was detected in the milk of lactating rats and in the plasma of nursing pups without effects on the nursing pups [see *Data*].

The development and health benefits of breastfeeding should be considered along with the mother's clinical need for EPCLUSA and any potential adverse effects on the breastfed child from EPCLUSA or from the underlying maternal condition.

If EPCLUSA is administered with ribavirin, the nursing mother's information for ribavirin also applies to this combination regimen. Refer to the ribavirin prescribing information for more information on use during lactation.

Data

Sofosbuvir: No effects of sofosbuvir on growth and postnatal development were observed in nursing pups at the highest dose tested in rats. Maternal systemic exposure (AUC) to the predominant circulating metabolite of sofosbuvir (GS-331007) was approximately 5 times the exposure in humans at the RHD, with exposure of approximately 2% that of maternal exposure observed in nursing pups on lactation day 10. In a lactation study, sofosbuvir metabolites (primarily GS-331007) were excreted into the milk of lactating rats following administration of a single oral dose of

sofosbuvir (20 mg/kg) on lactation day 2, with milk concentrations of approximately 10% that of maternal plasma concentrations observed 1-hour post-dose.

Velpatasvir: No effects of velpatasvir on growth and postnatal development were observed in nursing pups at the highest dose tested in rats. Maternal systemic exposure (AUC) to velpatasvir was approximately 5 times the exposure in humans at the RHD. Velpatasvir was present in the milk (approximately 173% that of maternal plasma concentrations) of lactating rats following a single oral dose of velpatasvir (30 mg/kg), and systemic exposure (AUC) in nursing pups was approximately 4% that of maternal exposure on lactation day 10.

8.3 Females and Males of Reproductive Potential

If EPCLUSA is administered with ribavirin, the information for ribavirin with regard to pregnancy testing, contraception, and infertility also applies to this combination regimen. Refer to ribavirin prescribing information for additional information.

8.4 Pediatric Use

The pharmacokinetics, safety, and effectiveness of EPCLUSA for treatment of HCV genotype 1, 2, 3, 4, or 6 infection in treatment-naïve and treatment-experienced pediatric patients 3 years of age and older without cirrhosis or with compensated cirrhosis have been established in an open-label, multicenter clinical trial (Study 1143, N=216; 190 treatment-naïve, 26 treatment-experienced). No clinically meaningful differences in pharmacokinetics were observed in comparison to those observed in adults.

The safety and effectiveness in pediatric subjects were comparable to those observed in adults. However, among the 41 pediatric subjects less than 6 years of age, vomiting and product use issue (spitting up the drug) were reported more frequently (15% and 10%, respectively; all Grade 1 or 2) compared to subjects 6 years of age and older. Five subjects (12%) discontinued treatment after vomiting or spitting up the drug [see *Dosage and Administration (2.4, 2.5), Adverse Reactions (6.1), Clinical Pharmacology (12.3), and Clinical Studies (14.7)*].

The safety and effectiveness of EPCLUSA for treatment of HCV genotype 5 in pediatric patients 3 years of age and older without cirrhosis or with compensated cirrhosis are supported by sofosbuvir, GS-331007, and velpatasvir exposures in adults and pediatric patients [see *Dosage and Administration (2.2 and 2.4), Adverse Reactions (6.1), Clinical Pharmacology (12.3), and Clinical Studies (14.7)*]. Similar rationale is used to support dosing recommendations for pediatric patients with HCV genotype 1, 2, 3, 4, 5, or 6 infection who have decompensated cirrhosis (Child-Pugh B or C).

In patients with severe renal impairment, including those requiring dialysis, exposures of GS-331007, the inactive metabolite of sofosbuvir, are increased [see *Clinical Pharmacology (12.3)*]. No data are available regarding the safety of EPCLUSA in pediatric patients with renal impairment [see *Use in Specific Populations (8.6)*].

The safety and effectiveness of EPCLUSA have not been established in pediatric patients less than 3 years of age.

8.5 Geriatric Use

Clinical trials of EPCLUSA included 156 subjects aged 65 and over (12% of total number of subjects in the Phase 3 clinical trials). No overall differences in safety or effectiveness were observed between these subjects and younger subjects, and other reported clinical experience has not identified differences in responses between the elderly and younger patients, but greater sensitivity of some older individuals cannot be ruled out. No dosage adjustment of EPCLUSA is warranted in geriatric patients [see *Clinical Pharmacology (12.3)*].

8.6 Renal Impairment

No dosage adjustment of EPCLUSA is recommended for patients with mild, moderate, or severe renal impairment, including ESRD requiring dialysis [see *Dosage and Administration (2.6)*, *Adverse Reactions (6.1)*, *Clinical Pharmacology (12.3)*, and *Clinical Studies (14.6)*]. No safety data are available in subjects with both decompensated cirrhosis and severe renal impairment, including ESRD requiring dialysis. Additionally, no safety data are available in pediatric patients with renal impairment [see *Use in Specific Populations (8.4)*]. Refer to ribavirin tablet prescribing information regarding use of ribavirin in patients with renal impairment.

8.7 Hepatic Impairment

No dosage adjustment of EPCLUSA is recommended for patients with mild, moderate, or severe hepatic impairment (Child-Pugh Class A, B, or C) [see *Adverse Reactions (6.1)*, *Clinical Pharmacology (12.3)*, and *Clinical Studies (14)*].

Clinical and hepatic laboratory monitoring (including direct bilirubin), as clinically indicated, is recommended for patients with decompensated cirrhosis receiving treatment with EPCLUSA and ribavirin [see *Adverse Reactions (6.1)*].

10 OVERDOSAGE

No specific antidote is available for overdose with EPCLUSA. If overdose occurs the patient must be monitored for evidence of toxicity. Treatment of overdose with EPCLUSA consists of general supportive measures including monitoring of vital signs as well as observation of the clinical status of the patient. Hemodialysis can efficiently remove the predominant circulating metabolite of sofosbuvir, GS-331007, with an extraction ratio of 53%. Hemodialysis is unlikely to result in significant removal of velpatasvir since velpatasvir is highly bound to plasma protein.

11 DESCRIPTION

Tablets

EPCLUSA is a fixed-dose combination tablet containing sofosbuvir and velpatasvir for oral administration. Sofosbuvir is a nucleotide analog HCV NS5B polymerase inhibitor and velpatasvir is an NS5A inhibitor.

Each 400 mg/100 mg tablet contains 400 mg sofosbuvir and 100 mg velpatasvir, and each 200 mg/50 mg tablet contains 200 mg sofosbuvir and 50 mg velpatasvir. The tablets include the following inactive ingredients: copovidone, croscarmellose sodium, magnesium stearate, and microcrystalline cellulose. The tablets are film-coated with a coating material containing the following inactive ingredients: iron oxide red, polyethylene glycol, polyvinyl alcohol, talc, and titanium dioxide.

Pellets

EPCLUSA oral pellets are for oral administration, supplied as small, white to off-white pellets in unit-dose packets. Each unit-dose of EPCLUSA oral pellets contains either 200 mg sofosbuvir and 50 mg velpatasvir or 150 mg sofosbuvir and 37.5 mg velpatasvir and the following inactive ingredients: colloidal silicon dioxide, copovidone, croscarmellose sodium, lactose monohydrate, magnesium stearate, and microcrystalline cellulose. The oral pellets are film-coated with a coating material containing the following inactive ingredients: amino methacrylate copolymer, colloidal silicon dioxide, hypromellose, L-tartaric acid, polyethylene glycol, stearic acid, talc, and titanium dioxide.

Sofosbuvir: The IUPAC name for sofosbuvir is (S)-isopropyl 2-((S)-(((2R,3R,4R,5R)-5-(2,4-dioxo-3,4-dihydropyrimidin-1(2H)-yl)-4-fluoro-3-hydroxy-4-methyltetrahydrofuran-2-yl)methoxy)-(phenoxy)phosphorylamino)propanoate. It has a molecular formula of $C_{22}H_{29}FN_3O_9P$ and a molecular weight of 529.45. It has the following structural formula:

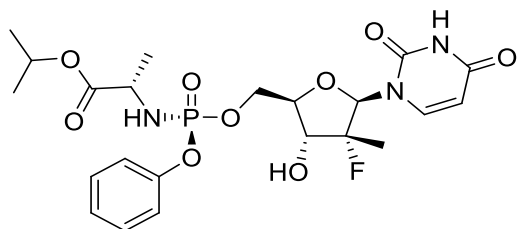

Sofosbuvir is a white to off-white crystalline solid with a solubility of at least 2 mg/mL across the pH range of 2–7.7 at 37 °C and is slightly soluble in water.

Velpatasvir: The IUPAC name for velpatasvir is methyl {(1R)-2-[(2S,4S)-2-(5-{2-[(2S,5S)-1-[(2S)-2-[(methoxycarbonyl)amino]-3-methylbutanoyl]-5-methylpyrrolidin-2-yl]-1,11-dihydro[2]benzopyrano[4',3':6,7]naphtho[1,2-d]imidazol-9-yl)-1H-imidazol-2-yl)-4-(methoxymethyl)pyrrolidin-1-yl]-2-oxo-1-phenylethyl}carbamate. It has a molecular formula of $C_{49}H_{54}N_8O_8$ and a molecular weight of 883.0. It has the following structural formula:

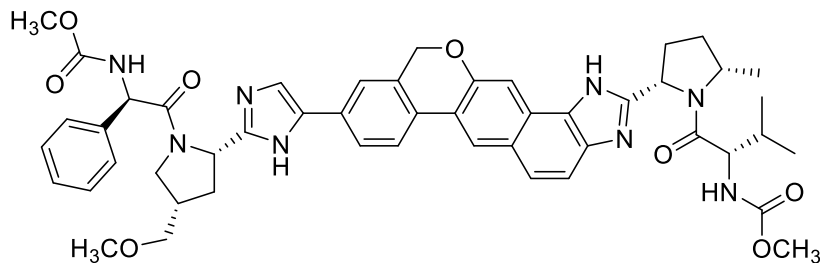

Velpatasvir is practically insoluble (less than 0.1 mg/mL) above pH 5, slightly soluble (3.6 mg/mL) at pH 2, and soluble (greater than 36 mg/mL) at pH 1.2.

12 CLINICAL PHARMACOLOGY

12.1 Mechanism of Action

EPCLUSA is a fixed-dose combination of sofosbuvir and velpatasvir, which are direct-acting antiviral agents against the hepatitis C virus [see *Microbiology* (12.4)].

12.2 Pharmacodynamics

Cardiac Electrophysiology

The effect of sofosbuvir 400 mg (recommended dosage) and 1200 mg (3 times the recommended dosage) on QTc interval was evaluated in an active-controlled (moxifloxacin 400 mg) thorough QT trial. At a dose 3 times the recommended dose, sofosbuvir does not prolong QTc to any clinically relevant extent.

The effect of velpatasvir 500 mg (5 times the recommended dosage) was evaluated in an active-controlled (moxifloxacin 400 mg) thorough QT trial. At a dose 5 times the recommended dose, velpatasvir does not prolong QTc interval to any clinically relevant extent.

12.3 Pharmacokinetics

The pharmacokinetic properties of the components of EPCLUSA are provided in Table 5. The multiple dose pharmacokinetic parameters of sofosbuvir and its metabolite, GS-331007, and velpatasvir are provided in Table 6.

Table 5 Pharmacokinetic Properties of the Components of EPCLUSA

	Sofosbuvir	Velpatasvir
Absorption		
T _{max} (hr)	0.5–1	3
Effect of moderate meal (relative to fasting) ^a	↑ 60%	↑ 34%
Effect of high fat meal (relative to fasting) ^a	↑ 78%	↑ 21%
Distribution		
% Bound to human plasma proteins	61–65	>99.5
Blood-to-plasma ratio	0.7	0.52–0.67
Metabolism		
Metabolism	Cathepsin A CES1 HINT1	CYP2B6 CYP2C8 CYP3A4
Elimination		
Major route of elimination	SOF: metabolism GS-331007 ^b : glomerular filtration and active tubular secretion	Biliary excretion as parent (77%)
t _{1/2} (hr) ^c	SOF: 0.5 GS-331007 ^b : 25	15
% Of dose excreted in urine ^d	80 ^e	0.4
% Of dose excreted in feces ^d	14	94

CES1 = carboxylesterase 1; HINT1 = histidine triad nucleotide-binding protein 1.

- Values refer to mean systemic exposure. Moderate meal = ~600 kcal, 30% fat; high fat meal = ~800 kcal, 50% fat. EPCLUSA can be taken with or without food.
- GS-331007 is the primary circulating nucleoside metabolite of SOF.
- t_{1/2} values refer to median terminal plasma half-life.
- Single dose administration of [¹⁴C] SOF or [¹⁴C] VEL in mass balance studies.
- Predominantly as GS-331007.

Table 6 Multiple Dose Pharmacokinetic Parameters of Sofosbuvir and its Metabolite, GS-331007, and Velpatasvir Following Oral Administration of EPCLUSA in HCV-Infected Adults

Parameter Mean (%CV)	Sofosbuvir ^a	GS-331007 ^b	Velpatasvir ^c
C _{max} (ng/mL)	567 (30.7)	898 (26.7)	259 (54.3)
AUC _{tau} (ng•hr/mL)	1268 (38.5)	14372 (28.0)	2980 (51.3)
C _{trough} (ng/mL)	NA	-	42 (67.3)

CV = coefficient of variation; NA = not applicable.

- a. From Population PK analysis, N = 666
- b. From Population PK analysis, N = 1029
- c. From Population PK analysis, N = 1025

Sofosbuvir and GS-331007 AUC₀₋₂₄ and C_{max} were similar in healthy adult subjects and subjects with HCV infection. Relative to healthy subjects (N=331), velpatasvir AUC₀₋₂₄ and C_{max} were 37% lower and 42% lower, respectively, in HCV-infected subjects.

Velpatasvir AUC increases in a greater than proportional manner from 5 to 50 mg and in a less than proportional manner from 50 to 450 mg in healthy volunteers. However, velpatasvir exhibited more than or near dose-proportional increase in exposures 25 mg to 150 mg in HCV-infected patients when coadministered with sofosbuvir. Sofosbuvir and GS-331007 AUCs are near dose-proportional over the dose range of 200 mg to 1200 mg.

Specific Populations

Pediatric Patients: The pharmacokinetics of sofosbuvir, GS-331007, and velpatasvir were determined in HCV genotype 1, 2, 3, 4, or 6 infected pediatric subjects 3 years of age and older receiving a daily dose of EPCLUSA as described below in Table 7. Sofosbuvir AUC_{tau} and C_{max} and velpatasvir C_{max} values were 67%, 69%, and 78% higher in pediatric subjects ≥30 kg, 68%, 70%, and 96% higher in pediatric subjects 17 to <30 kg, and 103%, 135%, and 92% higher in pediatric subjects <17 kg compared to those observed in adults. These differences were not considered clinically significant. GS-331007 exposures and velpatasvir AUC_{tau} and C_{tau} values in pediatric subjects were similar to those observed in adults.

Table 7 Exposures of Sofosbuvir, GS-331007, and Velpatasvir at Steady-State in HCV-Infected Pediatric Subjects 3 Years of Age and Older^a

Weight Group	Dose	PK Parameter	Mean (%CV)		
			Sofosbuvir	GS-331007	Velpatasvir
<17 kg ^b	150/37.5 mg	C _{max} (ng/mL)	1550 (65.2)	1090 (17.0)	488 (46.6)
		AUC _{tau} (ng•hr/mL)	2830 (63.7)	11900 (19.7)	4480 (53.4)
		C _{trough} (ng/mL)	NA	-	57.4 (82.7)
17 to <30 kg ^c	200/50 mg	C _{max} (ng/mL)	1200 (73.8)	1070 (27.2)	483 (39.5)
		AUC _{tau} (ng•hr/mL)	2280 (55.6)	11400 (43.3)	4090 (38.5)
		C _{trough} (ng/mL)	NA	-	43 (65.8)
≥30 kg ^d	400/100 mg	C _{max} (ng/mL)	1310 (91.4)	1180 (24.6)	456 (56.4)
		AUC _{tau} (ng•hr/mL)	2570 (82.8)	13600 (27.6)	4240 (46.7)
		C _{trough} (ng/mL)	NA	-	42.2 (66.4)

CV = coefficient of variation; NA = not applicable.

a. Population PK derived parameters

b. Sofosbuvir N=11; GS-331007 N=11; Velpatasvir N=11

c. Sofosbuvir N=62; GS-331007 N=64; Velpatasvir N=64

d. Sofosbuvir N=90; GS-331007 N=101; Velpatasvir N=101

The pharmacokinetics of sofosbuvir, GS-331007 and velpatasvir have not been established in pediatric subjects less than 3 years of age [see *Use in Specific Populations (8.4) and Clinical Studies (14.7)*].

Geriatric Patients: Population pharmacokinetic analysis in HCV-infected subjects showed that within the age range (18 to 82 years) analyzed, age did not have a clinically relevant effect on the exposure to sofosbuvir, GS-331007, or velpatasvir [see *Use in Specific Populations (8.5)*].

Patients with Renal Impairment:

The pharmacokinetics of sofosbuvir were studied in HCV negative subjects with mild (eGFR between 50 to less than 80 mL/min/1.73 m²), moderate (eGFR between 30 to less than 50 mL/min/1.73 m²), severe renal impairment (eGFR less than 30 mL/min/1.73 m²), and subjects with ESRD requiring hemodialysis following a single 400 mg dose of sofosbuvir. Relative to subjects with normal renal function (eGFR greater than 80 mL/min/1.73 m²), the sofosbuvir AUC_{0-inf} was 61%, 107%, and 171% higher in subjects with mild, moderate, and severe renal impairment, while the GS-331007 AUC_{0-inf} was 55%, 88%, and 451% higher, respectively.

In subjects with ESRD, relative to subjects with normal renal function, sofosbuvir and GS-331007 AUC_{0-inf} was 28% and 1280% higher when sofosbuvir was dosed 1 hour before hemodialysis compared with 60% and 2070% higher when sofosbuvir was dosed 1 hour after hemodialysis, respectively. A 4-hour hemodialysis session removed approximately 18% of administered dose [see *Dosage and Administration (2.6) and Use in Specific Populations (8.6)*].

The pharmacokinetics of velpatasvir were studied with a single dose of 100 mg velpatasvir in HCV negative subjects with severe renal impairment (eGFR less than 30 mL/min by Cockcroft-Gault). No clinically relevant differences in velpatasvir pharmacokinetics were observed between healthy subjects and subjects with severe renal impairment [see *Use in Specific Populations (8.6)*].

The pharmacokinetics of sofosbuvir, GS-331007, and velpatasvir were studied in HCV-infected subjects with ESRD requiring dialysis treated with EPCLUSA for 12 weeks. The results were generally consistent with those in HCV negative subjects with ESRD requiring dialysis.

Patients with Hepatic Impairment:

The pharmacokinetics of sofosbuvir were studied following 7-day dosing of 400 mg sofosbuvir in HCV-infected subjects with moderate and severe hepatic impairment (Child-Pugh Class B and C, respectively). Relative to subjects with normal hepatic function, the sofosbuvir AUC₀₋₂₄ were 126% and 143% higher in moderate and severe hepatic impairment, while the GS-331007 AUC₀₋₂₄ were 18% and 9% higher, respectively. Population pharmacokinetics analysis in HCV-infected subjects indicated that cirrhosis (including decompensated cirrhosis) had no clinically relevant effect on the exposure of sofosbuvir and GS-331007 [see *Use in Specific Populations (8.7)*].

The pharmacokinetics of velpatasvir were studied with a single dose of 100 mg velpatasvir in HCV negative subjects with moderate and severe hepatic impairment (Child-Pugh Class B and C). Velpatasvir plasma exposure (AUC_{inf}) was similar in subjects with moderate hepatic impairment, severe hepatic impairment, and control subjects with normal hepatic function. Population pharmacokinetics analysis in HCV-infected subjects indicated that cirrhosis (including decompensated cirrhosis) had no clinically relevant effect on the exposure of velpatasvir [see *Use in Specific Populations (8.7)*].

Race: Population pharmacokinetics analysis in HCV-infected subjects indicated that race had no clinically relevant effect on the exposure of sofosbuvir, GS-331007, or velpatasvir.

Gender: Population pharmacokinetics analysis in HCV-infected subjects indicated that gender had no clinically relevant effect on the exposure of sofosbuvir, GS-331007, or velpatasvir.

Drug Interaction Studies

After oral administration of EPCLUSA, sofosbuvir is rapidly absorbed and subject to extensive first-pass hepatic extraction (hydrolysis followed by sequential phosphorylation) to form the pharmacologically active triphosphate. In clinical pharmacology studies, both sofosbuvir and the primary circulating metabolite GS-331007 (dephosphorylated nucleotide metabolite) were monitored for purposes of pharmacokinetic analyses.

Sofosbuvir and velpatasvir are substrates of drug transporters P-gp and BCRP while GS-331007 is not. Velpatasvir is also transported by OATP1B1 and OATP1B3. In vitro, slow metabolic turnover of velpatasvir by CYP2B6, CYP2C8, and CYP3A4 was

observed. Inducers of P-gp and/or moderate to strong inducers of CYP2B6, CYP2C8, or CYP3A4 (e.g., rifampin, St. John's wort, carbamazepine) may decrease plasma concentrations of sofosbuvir and/or velpatasvir, leading to reduced therapeutic effect of EPCLUSA [see *Warnings and Precautions (5.3) and Drug Interactions (7.3)*]. Coadministration with drugs that inhibit P-gp and/or BCRP may increase sofosbuvir and/or velpatasvir plasma concentrations without increasing GS-331007 plasma concentration. Drugs that inhibit CYP2B6, CYP2C8, or CYP3A4 may increase plasma concentration of velpatasvir.

Velpatasvir is an inhibitor of drug transporter P-gp, BCRP, OATP1B1, OATP1B3, and OATP2B1, and its involvement in drug interactions with these transporters is primarily limited to the process of absorption. At clinically relevant concentration, velpatasvir is not an inhibitor of hepatic transporters OATP1A2 or OCT1, renal transporters OCT2, OAT1, OAT3, or MATE1, or CYP or UGT1A1 enzymes.

Sofosbuvir and GS-331007 are not inhibitors of drug transporters P-gp, BCRP, OATP1B1, OATP1B3, and OCT1 and GS-331007 is not an inhibitor of OAT1, OAT3, OCT2, and MATE1. Sofosbuvir and GS-331007 are not inhibitors or inducers of CYP or UGT1A1 enzymes.

The effects of coadministered drugs on the exposure of sofosbuvir, GS-331007, and velpatasvir are shown in Table 8. The effects of sofosbuvir, velpatasvir, or EPCLUSA on the exposure of coadministered drugs are shown in Table 9 [see *Drug Interactions (7)*].

Table 8 Drug Interactions: Changes in Pharmacokinetic Parameters for Sofosbuvir, GS-331007, and Velpatasvir in the Presence of the Coadministered Drug^a

Coadministered Drug	Dose of Coadministered Drug (mg)	SOF Dose (mg)	VEL Dose (mg)	N	Mean Ratio (90% CI) of Sofosbuvir, GS-331007, and Velpatasvir PK With/Without Coadministered Drug No Effect=1.00			
					C _{max}	AUC	C _{min}	
Atazanavir/ ritonavir + emtricitabine/ tenofovir DF	300/100 + 200/300 once daily	400 once daily	100 once daily	24	sofosbuvir	1.12 (0.97, 1.29)	1.22 (1.12, 1.33)	NA
					GS-331007	1.21 (1.12, 1.29)	1.32 (1.27, 1.36)	1.42 (1.37, 1.49)
					velpatasvir	1.55 (1.41, 1.71)	2.42 (2.23, 2.64)	4.01 (3.57, 4.50)
Carbamazepine	300 twice daily	400 single dose	ND	24	sofosbuvir	0.52 (0.43, 0.62)	0.52 (0.46, 0.59)	NA
					GS-331007	1.04 (0.97, 1.11)	0.99 (0.94, 1.04)	NA

Coadministered Drug	Dose of Coadministered Drug (mg)	SOF Dose (mg)	VEL Dose (mg)	N	Mean Ratio (90% CI) of Sofosbuvir, GS-331007, and Velpatasvir PK With/Without Coadministered Drug No Effect=1.00			
						C _{max}	AUC	C _{min}
Cyclosporine	600 single dose	400 single dose	ND	19	sofosbuvir	2.54 (1.87, 3.45)	4.53 (3.26, 6.30)	NA
					GS-331007	0.60 (0.53, 0.69)	1.04 (0.90, 1.20)	NA
		ND	100 single dose	12	velpatasvir	1.56 (1.22, 2.01)	2.03 (1.51, 2.71)	NA
Darunavir/ ritonavir + emtricitabine/ tenofovir DF	800/100 + 200/300 once daily	400 once daily	100 once daily	29	sofosbuvir	0.62 (0.54, 0.71)	0.72 (0.66, 0.80)	NA
					GS-331007	1.04 (0.99, 1.08)	1.13 (1.08, 1.18)	1.13 (1.06, 1.19)
					velpatasvir	0.76 (0.65, 0.89)	0.84 (0.72, 0.98)	1.01 (0.87, 1.18)
Efavirenz/ emtricitabine/ tenofovir DF ^b	600/200/300 once daily	400 once daily	100 once daily	14	sofosbuvir	1.38 (1.14, 1.67)	0.97 (0.83, 1.14)	NA
					GS-331007	0.86 (0.80, 0.93)	0.90 (0.85, 0.96)	1.01 (0.95, 1.07)
					velpatasvir	0.53 (0.43, 0.64)	0.47 (0.39, 0.57)	0.43 (0.36, 0.52)
Elvitegravir/ cobicistat/ emtricitabine/ tenofovir alafenamide ^c	150/150/200/10 once daily	400 once daily	100 once daily	24	sofosbuvir	1.23 (1.07, 1.42)	1.37 (1.24, 1.52)	NA
					GS-331007	1.29 (1.25, 1.33)	1.48 (1.43, 1.53)	1.58 (1.52, 1.65)
					velpatasvir	1.30 (1.17, 1.45)	1.50 (1.35, 1.66)	1.60 (1.44, 1.78)
Elvitegravir/ cobicistat/ emtricitabine/ tenofovir DF ^d	150/150/200/30 0 once daily	400 once daily	100 once daily	24	sofosbuvir	1.01 (0.85, 1.19)	1.24 (1.13, 1.37)	NA
					GS-331007	1.13 (1.07, 1.18)	1.35 (1.30, 1.40)	1.45 (1.38, 1.52)
					velpatasvir	1.05 (0.93, 1.19)	1.19 (1.07, 1.34)	1.37 (1.22, 1.54)
Famotidine	40 single dose simultaneously with EPCLUSA	400 single dose	100 single dose	60	sofosbuvir	0.92 (0.82, 1.05)	0.82 (0.74, 0.91)	NA
					GS-331007	0.84 (0.78, 0.89)	0.94 (0.91, 0.98)	NA
					velpatasvir	0.80 (0.70, 0.91)	0.81 (0.71, 0.91)	NA
	40 single dose 12 hours prior to EPCLUSA			60	sofosbuvir	0.77 (0.68, 0.87)	0.80 (0.73, 0.88)	NA
					GS-331007	1.20 (1.13, 1.28)	1.04 (1.01, 1.08)	NA
					velpatasvir	0.87 (0.76, 1.00)	0.85 (0.74, 0.97)	NA
Ketoconazole	200 twice daily	ND	100 single dose	12	velpatasvir	1.29 (1.02, 1.64)	1.71 (1.35, 2.18)	NA

Coadministered Drug	Dose of Coadministered Drug (mg)	SOF Dose (mg)	VEL Dose (mg)	N	Mean Ratio (90% CI) of Sofosbuvir, GS-331007, and Velpatasvir PK With/Without Coadministered Drug No Effect=1.00			
						C _{max}	AUC	C _{min}
Lopinavir/ ritonavir + emtricitabine/ tenofovir DF	4x200/50 + 200/300 once daily	400 once daily	100 once daily	24	sofosbuvir	0.59 (0.49, 0.71)	0.71 (0.64, 0.78)	NA
					GS-331007	1.01 (0.98, 1.05)	1.15 (1.09, 1.21)	1.15 (1.07, 1.25)
					velpatasvir	0.70 (0.59, 0.83)	1.02 (0.89, 1.17)	1.63 (1.43, 1.85)
Methadone	30 to 130 daily	400 once daily	ND	14	sofosbuvir	0.95 (0.68, 1.33)	1.30 (1.00, 1.69)	NA
					GS-331007	0.73 (0.65, 0.83)	1.04 (0.89, 1.22)	NA
Omeprazole	20 once daily simultaneously with EPCLUSA	400 single dose fasted	100 single dose fasted	60	sofosbuvir	0.66 (0.55, 0.78)	0.71 (0.60, 0.83)	NA
					GS-331007	1.18 (1.10, 1.26)	1.00 (0.95, 1.05)	NA
					velpatasvir	0.63 (0.50, 0.78)	0.64 (0.52, 0.79)	NA
	20 once daily 12 hours prior to EPCLUSA	400 single dose fasted	100 single dose fasted	60	sofosbuvir	0.55 (0.47, 0.64)	0.56 (0.49, 0.65)	NA
					GS-331007	1.26 (1.18, 1.34)	0.97 (0.94, 1.01)	NA
					velpatasvir	0.43 (0.35, 0.54)	0.45 (0.37, 0.55)	NA
	20 once daily 2 hours prior to EPCLUSA	400 single dose fed ^e	100 single dose fed ^e	40	sofosbuvir	0.84 (0.68, 1.03)	1.08 (0.94, 1.25)	NA
					GS-331007	0.94 (0.88, 1.02)	0.99 (0.96, 1.03)	NA
					velpatasvir	0.52 (0.43, 0.64)	0.62 (0.51, 0.75)	NA
	20 once daily 4 hours after EPCLUSA	400 single dose fed ^e	100 single dose fed ^e	38	sofosbuvir	0.79 (0.68, 0.92)	1.05 (0.94, 1.16)	NA
					GS-331007	0.91 (0.85, 0.98)	0.99 (0.95, 1.02)	NA
					velpatasvir	0.67 (0.58, 0.78)	0.74 (0.63, 0.86)	NA
40 once daily 4 hours after EPCLUSA	400 single dose fed ^e	100 single dose fed ^e	40	sofosbuvir	0.70 (0.57, 0.87)	0.91 (0.76, 1.08)	NA	
				GS-331007	1.01 (0.96, 1.07)	0.99 (0.94, 1.03)	NA	
				velpatasvir	0.44 (0.34, 0.57)	0.47 (0.37, 0.60)	NA	
Rifabutin	300 once daily	400 single dose	ND	20	sofosbuvir	0.64 (0.53, 0.77)	0.76 (0.63, 0.91)	NA
					GS-331007	1.15 (1.03, 1.27)	1.03 (0.95, 1.12)	NA

Coadministered Drug	Dose of Coadministered Drug (mg)	SOF Dose (mg)	VEL Dose (mg)	N	Mean Ratio (90% CI) of Sofosbuvir, GS-331007, and Velpatasvir PK With/Without Coadministered Drug No Effect=1.00			
					C _{max}	AUC	C _{min}	
Rifampin	600 once daily	400 single dose	ND	17	sofosbuvir	0.23 (0.19, 0.29)	0.28 (0.24, 0.32)	NA
					GS-331007	1.23 (1.14, 1.34)	0.95 (0.88, 1.03)	NA
	600 single dose	ND	100 single dose	12	velpatasvir	0.29 (0.23, 0.37)	0.18 (0.15, 0.22)	NA
					velpatasvir	1.28 (1.05, 1.56)	1.46 (1.17, 1.83)	NA
Tacrolimus	5 single dose	400 single dose	ND	16	sofosbuvir	0.97 (0.65, 1.43)	1.13 (0.81, 1.57)	NA
					GS-331007	0.97 (0.83, 1.14)	1.00 (0.87, 1.13)	NA

NA = not available/not applicable, ND = not dosed, DF = disoproxil fumarate.

- All interaction studies conducted in healthy volunteers.
- Administered as ATRIPLA[®] (efavirenz, emtricitabine, and tenofovir DF fixed-dose combination).
- Administered as GENVOYA[®] (elvitegravir, cobicistat, emtricitabine, and tenofovir alafenamide fixed-dose combination).
- Administered as STRIBILD[®] (elvitegravir, cobicistat, emtricitabine, and tenofovir DF fixed-dose combination).
- EPCLUSA was administered under fasted conditions in the reference arms.

No effect on the pharmacokinetic parameters of sofosbuvir, GS-331007, or velpatasvir was observed with dolutegravir; the combination of emtricitabine, rilpivirine, and tenofovir DF; emtricitabine; raltegravir; or tenofovir DF.

Table 9 Changes in Pharmacokinetic Parameters for Coadministered Drug in the Presence of Sofosbuvir, Velpatasvir, or EPCLUSA^a

Coadministered Drug	Dose of Coadministered Drug (mg)	SOF Dose (mg)	VEL Dose (mg)	N	Mean Ratio (90% CI) of Coadministered Drug PK With/Without Sofosbuvir, Velpatasvir, or EPCLUSA No Effect=1.00		
					C _{max}	AUC	C _{min}
Atazanavir/ ritonavir + emtricitabine/ tenofovir DF ^b	atazanavir 300 once daily	400 once daily	100 once daily	24	1.09 (1.00, 1.19)	1.20 (1.10, 1.31)	1.39 (1.20, 1.61)
	ritonavir 100 once daily				0.89 (0.82, 0.97)	0.97 (0.89, 1.05)	1.29 (1.15, 1.44)
	emtricitabine 200 once daily				1.01 (0.96, 1.06)	1.02 (0.99, 1.04)	1.06 (1.02, 1.11)
	tenofovir DF 300 once daily				1.55 (1.43, 1.68)	1.30 (1.24, 1.36)	1.39 (1.31, 1.48)
Atorvastatin	40 single dose	400 once daily	100 once daily	26	1.68 (1.49, 1.89)	1.54 (1.45, 1.64)	NA

Coadministered Drug	Dose of Coadministered Drug (mg)	SOF Dose (mg)	VEL Dose (mg)	N	Mean Ratio (90% CI) of Coadministered Drug PK With/Without Sofosbuvir, Velpatasvir, or EPCLUSA No Effect=1.00		
					C _{max}	AUC	C _{min}
Darunavir/ ritonavir + emtricitabine/ tenofovir DF ^c	darunavir 800 once daily	400 once daily	100 once daily	29	0.90 (0.86, 0.95)	0.92 (0.87, 0.98)	0.87 (0.79, 0.95)
	ritonavir 100 once daily				1.07 (0.97, 1.17)	1.12 (1.05, 1.19)	1.09 (1.02, 1.15)
	emtricitabine 200 once daily				1.05 (1.01, 1.08)	1.05 (1.02, 1.08)	1.04 (0.98, 1.09)
	tenofovir DF 300 once daily				1.55 (1.45, 1.66)	1.39 (1.33, 1.44)	1.52 (1.45, 1.59)
Digoxin	0.25 single dose	ND	100	21	1.88 (1.71, 2.08)	1.34 (1.13, 1.60)	NA
Efavirenz/ emtricitabine/ tenofovir DF ^d	efavirenz 600 once daily	400 once daily	100 once daily	15	0.81 (0.74, 0.89)	0.85 (0.80, 0.91)	0.90 (0.85, 0.95)
	emtricitabine 200 once daily				1.07 (0.98, 1.18)	1.07 (1.00, 1.14)	1.10 (0.97, 1.25)
	tenofovir DF 300 once daily				1.77 (1.53, 2.04)	1.81 (1.68, 1.94)	2.21 (2.00, 2.43)
Elvitegravir/ cobicistat/ emtricitabine/ tenofovir alafenamide ^e	elvitegravir 150 once daily	400 once daily	100 once daily	24	0.87 (0.80, 0.94)	0.94 (0.88, 1.00)	1.08 (0.97, 1.20)
	cobicistat 150 once daily				1.16 (1.09, 1.23)	1.30 (1.23, 1.38)	2.03 (1.67, 2.48)
	emtricitabine 200 once daily				1.02 (0.97, 1.06)	1.01 (0.98, 1.04)	1.02 (0.97, 1.07)
	tenofovir alafenamide 10 once daily				0.80 (0.68, 0.94)	0.87 (0.81, 0.94)	NA
Elvitegravir/ cobicistat/ emtricitabine/ tenofovir DF ^f	elvitegravir 150 once daily	400 once daily	100 once daily	24	0.93 (0.86, 1.00)	0.93 (0.87, 0.99)	0.97 (0.91, 1.04)
	cobicistat 150 once daily				1.11 (1.06, 1.17)	1.23 (1.17, 1.29)	1.71 (1.54, 1.90)
	emtricitabine 200 once daily				1.02 (0.97, 1.08)	1.01 (0.98, 1.04)	1.06 (1.01, 1.11)
	tenofovir DF 300 once daily				1.36 (1.25, 1.47)	1.35 (1.29, 1.42)	1.45 (1.39, 1.51)
Emtricitabine/ rilpivirine/ tenofovir DF ^g	emtricitabine 200 once daily	400 once daily	100 once daily	24	0.95 (0.90, 1.00)	0.99 (0.97, 1.02)	1.05 (0.99, 1.11)
	rilpivirine 25 once daily				0.93 (0.88, 0.98)	0.95 (0.90, 1.00)	0.96 (0.90, 1.03)
	tenofovir DF 300 once daily				1.44 (1.33, 1.55)	1.40 (1.34, 1.46)	1.84 (1.76, 1.92)

Coadministered Drug	Dose of Coadministered Drug (mg)	SOF Dose (mg)	VEL Dose (mg)	N	Mean Ratio (90% CI) of Coadministered Drug PK With/Without Sofosbuvir, Velpatasvir, or EPCLUSA No Effect=1.00		
					C _{max}	AUC	C _{min}
Norelgestromin	norgestimate 0.180/0.215/0.25/ethinyl estradiol 0.025 once daily	ND	100 once daily	13	0.97 (0.88, 1.07)	0.90 (0.82, 0.98)	0.92 (0.83, 1.03)
		400 once daily	ND	15	1.07 (0.94, 1.22)	1.06 (0.92, 1.21)	1.07 (0.89, 1.28)
Norgestrel		ND	100 once daily	13	0.96 (0.78, 1.19)	0.91 (0.73, 1.15)	0.92 (0.73, 1.18)
		400 once daily	ND	15	1.18 (0.99, 1.41)	1.19 (0.98, 1.45)	1.23 (1.00, 1.51)
Ethinyl estradiol		ND	100 once daily	12	1.39 (1.17, 1.66)	1.04 (0.87, 1.24)	0.83 (0.65, 1.06)
		400 once daily	ND	15	1.15 (0.97, 1.36)	1.09 (0.94, 1.26)	0.99 (0.80, 1.23)
Pravastatin	40 single dose	ND	100 once daily	18	1.28 (1.08, 1.52)	1.35 (1.18, 1.54)	NA
Rosuvastatin	10 single dose	ND	100 once daily	18	2.61 (2.32, 2.92)	2.69 (2.46, 2.94)	NA
Raltegravir + emtricitabine/tenofovir DF	emtricitabine 200 once daily	400 once daily	100 once daily	30	1.08 (1.04, 1.12)	1.05 (1.03, 1.07)	1.02 (0.97, 1.08)
	tenofovir DF 300 once daily				1.46 (1.39, 1.54)	1.40 (1.34, 1.45)	1.70 (1.61, 1.79)
	raltegravir 400 twice daily				1.03 (0.74, 1.43)	0.97 (0.73, 1.28)	0.79 (0.42, 1.48)
Tacrolimus	5 single dose	400 single dose	ND	16	0.73 (0.59, 0.90)	1.09 (0.84, 1.40)	NA

NA = not available/not applicable, ND = not dosed, DF = disoproxil fumarate.

- All interaction studies conducted in healthy volunteers.
- Comparison based on exposures when administered as atazanavir/ritonavir + emtricitabine/tenofovir DF.
- Comparison based on exposures when administered as darunavir/ritonavir + emtricitabine/tenofovir DF.
- Administered as ATRIPLA (efavirenz, emtricitabine, and tenofovir DF fixed-dose combination).
- Administered as GENVOYA (elvitegravir, cobicistat, emtricitabine, and tenofovir alafenamide fixed-dose combination).
- Administered as STRIBILD (elvitegravir, cobicistat, emtricitabine, and tenofovir DF fixed-dose combination).
- Administered as COMPLERA® (emtricitabine, rilpivirine, and tenofovir DF fixed-dose combination).

No effect on the pharmacokinetic parameters of the following coadministered drugs was observed with EPCLUSA (dolutegravir or lopinavir/ritonavir) or its components sofosbuvir (cyclosporine or methadone) or velpatasvir (cyclosporine).

12.4 Microbiology

Mechanism of Action

Sofosbuvir is an inhibitor of the HCV NS5B RNA-dependent RNA polymerase, which is required for viral replication. Sofosbuvir is a nucleotide prodrug that undergoes intracellular metabolism to form the pharmacologically active uridine analog triphosphate (GS-461203), which can be incorporated into HCV RNA by the NS5B polymerase and acts as a chain terminator. In a biochemical assay, GS-461203 inhibited the polymerase activity of the recombinant NS5B from HCV genotype 1b, 2a, 3a, and 4a with an IC₅₀ value ranging from 0.36 to 3.3 micromolar. GS-461203 is neither an inhibitor of human DNA and RNA polymerases nor an inhibitor of mitochondrial RNA polymerase.

Velpatasvir is an inhibitor of the HCV NS5A protein, which is required for viral replication. Resistance selection in cell culture and cross-resistance studies indicate velpatasvir targets NS5A as its mode of action.

Antiviral Activity

The EC₅₀ values of sofosbuvir and velpatasvir against full-length or chimeric replicons encoding NS5B and NS5A sequences from the laboratory strains are presented in Table 10. The EC₅₀ values of sofosbuvir and velpatasvir against clinical isolates are presented in Table 11.

Table 10 Activity of Sofosbuvir and Velpatasvir Against Full Length or Chimeric Laboratory Replicons

Replicon Genotype	Sofosbuvir EC ₅₀ , nM ^a	Velpatasvir EC ₅₀ , nM ^a
1a	40	0.014
1b	110	0.016
2a	50	0.005–0.016 ^b
2b	15 ^c	0.002–0.006 ^b
3a	50	0.004
4a	40	0.009
4d	33.4	0.004
5a	15 ^c	0.021–0.054 ^d
6a	14–25 ^c	0.006–0.009
6e	NA	0.130 ^d

NA = not available.

a. Mean value from multiple experiments of same laboratory replicon.

b. Data from various strains of full-length NS5A replicons or chimeric NS5A replicons carrying full-length NS5A genes that contain L31 or M31 polymorphisms.

c. Stable chimeric 1b replicons carrying NS5B genes from genotype 2b, 5a, or 6a were used for testing.

d. Data from a chimeric NS5A replicon carrying NS5A amino acids 9-184.

Table 11 Activity of Sofosbuvir and Velpatasvir Against Transient Replicons Containing NS5A or NS5B from Clinical Isolates

Replicon Genotype	Replicons Containing NS5B from Clinical Isolates		Replicons Containing NS5A from Clinical Isolates	
	Number of clinical isolates	Median sofosbuvir EC ₅₀ , nM (range)	Number of clinical isolates	Median velpatasvir EC ₅₀ , nM (range)
1a	67	62 (29–128)	23	0.019 (0.011–0.078)
1b	29	102 (45–170)	34	0.012 (0.005–0.500)
2a	1	28	8	0.011 (0.006–0.364)
2b	14	30 (14–81)	16	0.002 (0.0003–0.007)
3a	106	81 (24–181)	38	0.005 (0.002–1.871)
4a	NA	NA	5	0.002 (0.001–0.004)
4d	NA	NA	10	0.007 (0.004–0.011)
4r	NA	NA	7	0.003 (0.002–0.006)
5a	NA	NA	42	0.005 (0.001–0.019)
6a	NA	NA	26	0.007 (0.0005–0.113)
6e	NA	NA	15	0.024 (0.005–0.433)

NA = not available.

Velpatasvir was not antagonistic in reducing HCV RNA levels in replicon cells when combined with sofosbuvir or interferon- α , ribavirin, an HCV NS3/4A protease inhibitor, or HCV NS5B non-nucleoside inhibitors.

Resistance

In Cell Culture

HCV replicons with reduced susceptibility to sofosbuvir have been selected in cell culture for multiple genotypes including 1b, 2a, 2b, 3a, 4a, 5a, and 6a. Reduced susceptibility to sofosbuvir was associated with the NS5B substitution S282T in all replicon genotypes examined. An M289L substitution developed along with the S282T substitution in genotype 2a, 5, and 6 replicons. Site-directed mutagenesis of the S282T substitution in replicons of genotypes 1 to 6 conferred 2- to 18-fold reduced susceptibility to sofosbuvir.

HCV genotype 1a, 1b, 2a, 3a, 4a, 5a, and 6a replicon variants with reduced susceptibility to velpatasvir were selected in cell culture. Variants developed amino acid substitutions at NS5A resistance-associated positions 24, 28, 30, 31, 32, 58, 92, and 93. Phenotypic analysis of site-directed mutant replicons of the selected NS5A substitutions showed that single and double combinations of L31V and Y93H/N in genotype 1a, the combination of L31V + Y93H in genotype 1b, Y93H/S in genotype 3a, and L31V and P32A/L/Q/R in genotype 6 conferred greater than 100-fold reduction in velpatasvir susceptibility. In the genotype 2a replicon, the single mutants F28S and Y93H showed 91-fold and 46-fold reduced susceptibility to velpatasvir, respectively. The single mutant Y93H conferred 3-fold reduced susceptibility to velpatasvir in genotype 4a replicons. Combinations of these NS5A substitutions often showed greater reductions in susceptibility to velpatasvir than single substitutions alone.

In Clinical Trials

Studies in Subjects without Cirrhosis and Subjects with Compensated Cirrhosis

In a pooled analysis of subjects without cirrhosis or with compensated cirrhosis who received EPCLUSA for 12 weeks in Phase 3 trials (ASTRAL-1, ASTRAL-2, and ASTRAL-3), 12 subjects (2 with genotype 1 [1a, 1c/h] and 10 with genotype 3a) qualified for resistance analysis due to virologic failure. No subjects with genotype 2, 4, 5, or 6 HCV infection experienced virologic failure.

Of the 2 genotype 1 virologic failure subjects, 1 subject had virus with emergent NS5A resistance substitution Y93N and the other had virus with emergent NS5A resistance substitutions Y93H and low-level K24M/T and L31I/V at virologic failure. The latter subject had genotype 1c/h virus at baseline harboring NS5A resistance polymorphisms (Q30R, L31M, H58P) relative to genotype 1a. No sofosbuvir NS5B nucleoside analog resistance-associated substitutions were observed at failure in the 2 subjects.

Of the 10 genotype 3a virologic failure subjects, NS5A resistance substitution Y93H was observed in all 10 subjects at failure (7 subjects had Y93H emerge post-treatment and 3 subjects had Y93H at baseline and post-treatment). Treatment-emergent sofosbuvir NS5B substitutions L314F (n=2) and L314I (n=1) were observed at high frequency (greater than or equal to 15%) in the NS5B polymerase in 3 genotype 3a subjects who relapsed: one in the EPCLUSA group and two in the sofosbuvir plus ribavirin 24-week group. In addition, low frequency (less than 4%) treatment-emergent L314P was detected in 2 genotype 3a subjects who relapsed, including one subject in the sofosbuvir plus ribavirin 24-week group in ASTRAL-3 and one in the EPCLUSA group in ASTRAL-4. The clinical significance of this substitution is unknown.

In Trial 2104 (liver transplant recipients), there were 2 virologic failures (1 subject with genotype 1a and 1 subject with genotype 3b). The genotype 1a virologic failure subject had virus with an NS5A K24R polymorphism at baseline and relapse, and treatment-emergent NS5A L31V. The genotype 3b virologic failure subject had virus at baseline and relapse with NS5A polymorphisms A30K+L31M, which are predominant in this subtype; treatment-emergent NS5B S282T was detected at relapse.

Studies in Subjects with Decompensated Cirrhosis

In the ASTRAL-4 trial in subjects with decompensated cirrhosis who received EPCLUSA with ribavirin for 12 weeks, 3 subjects (1 with genotype 1a and 2 with genotype 3a) qualified for resistance analysis due to virologic failure. No subjects with genotype 2 or 4 HCV infection who received EPCLUSA with ribavirin for 12 weeks experienced virologic failure.

The genotype 1 virologic failure subject had no NS5A or NS5B resistance substitutions at failure.

The 2 genotype 3a virologic failure subjects had the NS5A resistance substitutions Y93H and either low-level M28V or S38P emerge at failure. One of these subjects also developed low levels (less than 5%) of NS5B nucleoside analog inhibitor resistance substitutions N142T and E237G at failure.

In the ASTRAL-4 trial, 2 subjects treated with EPCLUSA for 12 or 24 weeks without ribavirin had emergent sofosbuvir NS5B resistance-associated substitutions S282T at

low levels (less than 5%) along with L159F. EPCLUSA for 12 or 24 weeks without ribavirin is not recommended in patients with decompensated cirrhosis.

Persistence of Resistance-Associated Substitutions

No data are available on the persistence of sofosbuvir or velpatasvir resistance-associated substitutions. NS5A resistance-associated substitutions observed with administration of other NS5A inhibitors have been found to persist for longer than 1 year in most patients. The long-term clinical impact of the emergence or persistence of virus containing sofosbuvir or velpatasvir resistance-associated substitutions is unknown.

Effect of Baseline HCV Polymorphisms on Treatment Response

Adults

Analyses were conducted to explore the association between relapse rates and pre-existing baseline NS5A resistance-associated polymorphisms (RAPs) (any change from reference at NS5A amino acid positions 24, 28, 30, 31, 58, 92, or 93) identified by population or deep sequencing analysis at a sensitivity threshold of 15% or higher for subjects without cirrhosis or with compensated cirrhosis in ASTRAL-1, ASTRAL-2, and ASTRAL-3 and subjects with decompensated cirrhosis in ASTRAL-4.

Studies in Subjects without Cirrhosis and Subjects with Compensated Cirrhosis

Among the subjects who received treatment with EPCLUSA for 12 weeks, 18% (37/209), 32% (38/117), 64% (149/232), 20% (56/274), 63% (73/115), 9% (3/34), and 83% (35/42) of subjects with genotype 1a, 1b, 2, 3, 4, 5, and 6 HCV, respectively, had baseline virus with NS5A RAPs.

Genotype 1: Among the 75 genotype 1 subjects who had baseline NS5A RAPs, one subject (1%) with Q30R, L31M, and H58P polymorphisms at baseline and compensated cirrhosis relapsed.

Genotype 3: Among the 56 genotype 3 subjects in ASTRAL-3 who had baseline NS5A RAPs, 4 subjects (7%) relapsed (3 with baseline Y93H and 1 with baseline A30K). Overall, 20% (3/15) of genotype 3 subjects with the Y93H polymorphism at baseline relapsed.

In a pooled analysis of clinical trials in subjects with HCV genotype 3 infection, the prevalence of the baseline NS5A Y93H polymorphism was 6% (104/1842). Among HCV genotype 3 infected subjects with the Y93H polymorphism who were treated with EPCLUSA for 12 weeks, 7% (2/28) of subjects without cirrhosis relapsed, and 40% (6/15) of subjects with compensated cirrhosis experienced virologic failure (5 relapse, 1 on-treatment).

Genotypes 2, 4, 5, and 6: The presence of baseline NS5A RAPs did not affect relapse rates for subjects with genotypes 2, 4, 5, and 6, because all achieved sustained virologic response (SVR) 12.

SVR12 was achieved in all 77 subjects who had baseline NS5B nucleoside analog inhibitor resistance polymorphisms including N142T, L159F, E/N237G, C/M289L/I, L320F/I/V, V321A/I, and S282G + V321I. The sofosbuvir NS5B nucleoside analog

inhibitor resistance substitution S282T was not detected in the baseline NS5B sequence of any subject using 1% deep sequencing cutoff in Phase 3 trials.

Studies in Subjects with Decompensated Cirrhosis

In ASTRAL-4, the prevalence of NS5A RAPs at baseline was 24% (48/198), 60% (6/10), 11% (4/37), and 63% (5/8) in GT1, GT2, GT3, and GT4 HCV subjects, respectively. No subjects with genotypes 2, 4 and 6 relapsed. There were no subjects with genotype 5 in this trial.

For genotype 1 subjects, the overall relapse rates were numerically lower for the 12-week EPCLUSA with ribavirin group (2%; 1/66) compared to EPCLUSA 12-week and 24-week treatment groups. For subjects with NS5A RAPs, relapse rates were 0% (0/17) compared to 2% (1/49) for subjects without NS5A RAPs in the 12-week EPCLUSA with ribavirin containing group.

For genotype 3 subjects, overall virologic failure rates were numerically lower for the 12-week EPCLUSA with ribavirin group (15%; 2/13) compared to EPCLUSA 12-week and 24-week treatment groups. There are insufficient data to determine the impact of HCV NS5A RAPs in genotype 3 subjects with decompensated cirrhosis.

Three subjects in the EPCLUSA with ribavirin 12-week group had baseline NS5B nucleoside analog inhibitor polymorphisms (N142T and L159F) using 1% deep sequencing cutoff and all 3 subjects achieved SVR12.

Pediatrics

In Study 1143, the presence of NS5A and NS5B RAPs did not impact treatment outcome; all pediatric subjects 3 years of age and older with baseline NS5A RAPs (15%; 29/199) or NS5B nucleoside inhibitor RAPs (3%; 6/195) achieved SVR following 12 weeks treatment with EPCLUSA.

Cross Resistance

Both sofosbuvir and velpatasvir were fully active against substitutions associated with resistance to other classes of direct-acting antivirals with different mechanisms of action, such as NS5B non-nucleoside inhibitors and NS3 protease inhibitors. The efficacy of EPCLUSA has not been established in patients who have previously failed treatment with other regimens that include an NS5A inhibitor.

13 NONCLINICAL TOXICOLOGY

13.1 Carcinogenesis, Mutagenesis, Impairment of Fertility

Carcinogenesis and Mutagenesis

Sofosbuvir: Sofosbuvir was not genotoxic in a battery of in vitro or in vivo assays, including bacterial mutagenicity, chromosome aberration using human peripheral blood lymphocytes, and in vivo mouse micronucleus assays.

Sofosbuvir was not carcinogenic in a 2-year mouse study (up to 200 mg/kg/day in males and 600 mg/kg/day in females) and in a 2-year rat study (up to 750 mg/kg/day), resulting in exposures of the predominant circulating metabolite GS-331007 of approximately 3 and 15 times (in mice) and 7 and 9 times (in rats), in males and

females, respectively, the exposure in humans at the recommended human dose (RHD).

Velpatasvir: Velpatasvir was not genotoxic in a battery of in vitro or in vivo assays, including bacterial mutagenicity, chromosome aberration using human peripheral blood lymphocytes, and in vivo rat micronucleus assays.

Velpatasvir was not carcinogenic in a 6-month rasH2 transgenic mouse study (up to 1000 mg/kg/day) and a 2-year rat carcinogenicity study (up to 200 mg/kg/day). The exposure of VEL in the 2-year rat study was approximately 6 times the exposure in humans at the RHD.

Impairment of Fertility

Sofosbuvir: Sofosbuvir had no effects on embryo-fetal viability or on fertility when evaluated in rats. At the highest dose tested, AUC exposure to the predominant circulating metabolite GS-331007 was approximately 4 times the exposure in humans at the RHD.

Velpatasvir: Velpatasvir had no effects on embryo-fetal viability or on fertility when evaluated in rats. At the highest dose tested, velpatasvir exposure was approximately 6 times the exposure in humans at the RHD.

14 CLINICAL STUDIES

14.1 Description of Clinical Trials

Table 12 presents the clinical trial design including different treatment groups that were conducted with EPCLUSA with and without ribavirin in subjects with chronic hepatitis C (HCV) genotype 1, 2, 3, 4, 5, and 6 infection. For detailed description of trial design and recommended regimen and duration [see *Dosage and Administration* (2.2, 2.3, and 2.4) and *Clinical Studies* (14.2, 14.3, 14.4, 14.5, 14.6, and 14.7)].

Table 12 Trials Conducted with EPCLUSA in Subjects with Genotype 1, 2, 3, 4, 5, or 6 HCV Infection

Trial	Population	EPCLUSA and Comparator Groups (Number of Subjects Treated)
ASTRAL-1 ^a (NCT02201940)	Genotype 1, 2, 4, 5, and 6 TN and TE ^b , without cirrhosis or with compensated cirrhosis	EPCLUSA 12 weeks (624) Placebo 12 weeks (116)
ASTRAL-2 ^c (NCT02220998)	Genotype 2 TN and TE ^b , without cirrhosis or with compensated cirrhosis	EPCLUSA 12 weeks (134) SOF + RBV 12 weeks (132)
ASTRAL-3 ^c (NCT02201953)	Genotype 3 TN and TE ^b , without cirrhosis or with compensated cirrhosis	EPCLUSA 12 weeks (277) SOF + RBV 24 weeks (275)
ASTRAL-5 ^c (NCT02480712)	Genotype 1, 2, 3, 4, 5, and 6 HCV/HIV- 1 coinfecting TN and TE ^b , without cirrhosis or with compensated cirrhosis	EPCLUSA 12 weeks (106)
ASTRAL-4 ^c (NCT02201901)	Genotype 1, 2, 3, 4, 5, and 6 TN and TE ^b , with CP class B decompensated cirrhosis	EPCLUSA 12 weeks (90) EPCLUSA + RBV 12 weeks (87) EPCLUSA 24 weeks (90)

2104 ^c (NCT02781571)	Genotype 1, 2, 3, and 4 TN and TE ^d liver transplant recipients, without cirrhosis or with compensated cirrhosis	EPCLUSA 12 weeks (79)
4062 ^c (NCT03036852)	Genotype 1, 2, 3, 4, and 6 TN and TE ^e without cirrhosis or with compensated cirrhosis, with ESRD requiring dialysis	EPCLUSA 12 weeks (59)
1143 ^c (NCT03022981)	Genotype 1, 2, 3, 4, and 6 TN and TE ^f pediatric subjects 3 years of age and older	EPCLUSA 12 weeks (214)

TN = treatment-naïve subjects; SOF = sofosbuvir; RBV = ribavirin; CP = Child-Pugh; ESRD = End Stage Renal Disease.

- Double-blind, placebo-controlled.
- TE = treatment-experienced subjects are those who have failed a peginterferon alfa/ribavirin based regimen with or without an HCV protease inhibitor (boceprevir, simeprevir, or telaprevir).
- Open-label.
- TE = treatment-experienced subjects are those who have failed a peginterferon alfa/ribavirin based regimen or an HCV-specific DAA-based regimen that does not include an NS5A inhibitor.
- TE = treatment-experienced subjects are those who have failed a peginterferon alfa/ribavirin or interferon/ribavirin based regimen.
- TE = treatment-experienced subjects are those who have failed an interferon-based regimen with or without ribavirin and with or without an HCV protease inhibitor (boceprevir, simeprevir, or telaprevir).

The ribavirin dosage was weight-based (1000 mg daily administered in two divided doses for subjects less than 75 kg and 1200 mg for those greater than or equal to 75 kg) and administered in two divided doses when used in combination with sofosbuvir in the ASTRAL-2 and ASTRAL-3 trials or in combination with EPCLUSA in the ASTRAL-4 trial. Ribavirin dosage adjustments were performed according to the ribavirin prescribing information. Serum HCV RNA values were measured during the clinical trials using the COBAS AmpliPrep/COBAS Taqman HCV test (version 2.0) with a lower limit of quantification (LLOQ) of 15 IU/mL. SVR12, defined as HCV RNA less than LLOQ at 12 weeks after the cessation of treatment, was the primary endpoint in all the trials. Relapse is defined as HCV RNA greater than or equal to LLOQ during the post-treatment period after having achieved HCV RNA less than LLOQ at the end of treatment. On-treatment virologic failure is defined as breakthrough, rebound, or non-response.

14.2 Clinical Trials in Subjects without Cirrhosis and Subjects with Compensated Cirrhosis

Genotype 1, 2, 4, 5, and 6 HCV Infected Adults (ASTRAL-1)

ASTRAL-1 was a randomized, double-blind, placebo-controlled trial that evaluated 12 weeks of treatment with EPCLUSA compared with 12 weeks of placebo in subjects with genotype 1, 2, 4, 5, or 6 HCV infection without cirrhosis or with compensated cirrhosis. Subjects with genotype 1, 2, 4, or 6 HCV infection were randomized in a 5:1 ratio to treatment with EPCLUSA or placebo for 12 weeks. Subjects with genotype 5 HCV infection were enrolled to the EPCLUSA group. Randomization was stratified by HCV genotype (1, 2, 4, 6, and indeterminate) and the presence or absence of compensated cirrhosis.

Demographics and baseline characteristics were balanced between the EPCLUSA and placebo group. Of the 740 treated subjects, the median age was 56 years (range: 18 to 82); 60% of the subjects were male; 79% were White, 9% were Black; 21% had a baseline body mass index at least 30 kg/m²; the proportions of subjects with genotype 1, 2, 4, 5, or 6 HCV infection were 53%, 17%, 19%, 5%, and 7%, respectively; 69% had

non-CC IL28B alleles (CT or TT); 74% had baseline HCV RNA levels at least 800,000 IU/mL; 19% had compensated cirrhosis; and 32% were treatment-experienced.

Table 13 presents SVR12 and other virologic outcomes in EPCLUSA-treated subjects in the ASTRAL-1 trial by HCV genotype. No subjects in the placebo group achieved SVR12.

Table 13 Study ASTRAL-1: Virologic Outcomes by HCV Genotype in EPCLUSA-Treated Subjects without Cirrhosis or with Compensated Cirrhosis (12 Weeks After Treatment)

	EPCLUSA 12 Weeks (N=624)							
	Total (all GTs) (N=624)	GT-1			GT-2 (N=104)	GT-4 (N=116)	GT-5 (N=35)	GT-6 (N=41)
		GT-1a (N=210)	GT-1b (N=118)	Total (N=328)				
SVR12	99% (618/624)	98% (206/210)	99% (117/118)	98% (323/328)	100% (104/104)	100% (116/116)	97% (34/35)	100% (41/41)
Outcome for Subjects without SVR								
On-Treatment Virologic Failure	0/624	0/210	0/118	0/328	0/104	0/116	0/35	0/41
Relapse ^a	<1% (2/623)	<1% (1/209)	1% (1/118)	1% (2/327)	0/104	0/116	0/35	0/41
Other ^b	1% (4/624)	1% (3/210)	0/118	1% (3/328)	0/104	0/116	3% (1/35)	0/41

GT = genotype; no subjects in the placebo group achieved SVR12.

a. The denominator for relapse is the number of subjects with HCV RNA <LLOQ at their last on-treatment assessment.

b. Other includes subjects who did not achieve SVR and did not meet virologic failure criteria.

Genotype 2 HCV Infected Adults (ASTRAL-2)

ASTRAL-2 was a randomized, open-label trial that evaluated 12 weeks of treatment with EPCLUSA compared with 12 weeks of treatment with SOF with ribavirin in subjects with genotype 2 HCV infection. Subjects were randomized in a 1:1 ratio to the treatment groups. Randomization was stratified by the presence or absence of compensated cirrhosis and prior treatment experience (treatment-naïve vs treatment-experienced).

Demographics and baseline characteristics were balanced across the two treatment groups. Of the 266 treated subjects, the median age was 58 years (range: 23 to 81); 59% of the subjects were male; 88% were White; 7% were Black; 33% had a baseline body mass index at least 30 kg/m²; 62% had non-CC IL28B alleles (CT or TT); 80% had baseline HCV RNA levels at least 800,000 IU/mL; 14% had compensated cirrhosis; and 15% were treatment-experienced.

Table 14 presents SVR12 and other virologic outcomes from the ASTRAL-2 trial.

Table 14 Study ASTRAL-2: Virologic Outcomes in Subjects with Genotype 2 HCV without Cirrhosis or with Compensated Cirrhosis (12 Weeks After Treatment)

	EPCLUSA 12 Weeks (N=134)	SOF + RBV 12 Weeks (N=132)
SVR12	99% (133/134)	94% (124/132)
	Treatment difference +5.2%; 95% confidence interval (+0.2% to +10.3%)	
Outcome for subjects without SVR		
On-Treatment Virologic Failure	0/134	0/132
Relapse ^a	0/133	5% (6/132)
Other ^b	1% (1/134)	2% (2/132)

SOF = sofosbuvir; RBV = ribavirin.

a. The denominator for relapse is the number of subjects with HCV RNA <LLOQ at the last on-treatment assessment.

b. Other includes subjects who did not achieve SVR12 and did not meet virologic failure criteria.

Genotype 3 HCV Infected Adults (ASTRAL-3)

ASTRAL-3 was a randomized, open-label trial that evaluated 12 weeks of treatment with EPCLUSA compared with 24 weeks of treatment with SOF with ribavirin in subjects with genotype 3 HCV infection. Subjects were randomized in a 1:1 ratio to the treatment groups. Randomization was stratified by the presence or absence of compensated cirrhosis and prior treatment experience (treatment-naïve vs treatment-experienced).

Demographics and baseline characteristics were balanced across the treatment groups. Of the 552 treated subjects, the median age was 52 years (range: 19 to 76); 62% of the subjects were male; 89% were White; 9% were Asian; 20% had a baseline body mass index at least 30 kg/m²; 61% had non-CC IL28B alleles (CT or TT); 70% had baseline HCV RNA levels at least 800,000 IU/mL; 30% had compensated cirrhosis; and 26% were treatment-experienced.

Table 15 presents SVR12 and other virologic outcomes from the ASTRAL-3 trial.

Table 15 Study ASTRAL-3: Virologic Outcomes in Subjects with Genotype 3 HCV without Cirrhosis or with Compensated Cirrhosis (12 Weeks After Treatment)

	EPCLUSA 12 Weeks (N=277)	SOF + RBV 24 Weeks (N=275)
SVR12	95% (264/277)	80% (221/275)
	Treatment difference +14.8%; 95% confidence interval (+9.6% to +20.0%)	
Outcome for subjects without SVR		
On-Treatment Virologic Failure	0/277	<1% (1/275)
Relapse ^a	4% (11/276)	14% (38/272)
Other ^b	1% (2/277)	5% (15/275)

SOF = sofosbuvir; RBV = ribavirin.

a. The denominator for relapse is the number of subjects with HCV RNA <LLOQ at the last on-treatment assessment.

b. Other includes subjects who did not achieve SVR and did not meet virologic failure criteria.

SVR12 for selected subgroups are presented in Table 16.

Table 16 Study ASTRAL-3: SVR12 by Prior Treatment and Presence/Absence of Compensated Cirrhosis in Subjects with Genotype 3 HCV

	EPCLUSA 12 Weeks		SOF + RBV 24 Weeks ^a	
	Treatment-Naïve (N=206)	Treatment-Experienced (N=71)	Treatment-Naïve (N=201)	Treatment-Experienced (N=69)
Without cirrhosis	98% (160/163)	94% (31/33) ^b	90% (141/156)	71% (22/31)
With compensated cirrhosis	93% (40/43)	89% (33/37)	73% (33/45)	58% (22/38)

SOF = sofosbuvir; RBV = ribavirin.

a. Five subjects with missing cirrhosis status in the SOF + RBV 24-week group were excluded from this subgroup analysis.

b. One treatment-experienced subject without cirrhosis treated with EPCLUSA had genotype 1a HCV infection at failure, indicating HCV re-infection, and is therefore excluded from this analysis.

14.3 Clinical Trial in Subjects Coinfected with HCV and HIV-1

ASTRAL-5 was an open-label trial that evaluated 12 weeks of treatment with EPCLUSA in subjects with genotype 1, 2, 3, 4, 5, or 6 HCV infection who were coinfecting with HIV-1. Subjects were on a stable HIV-1 antiretroviral therapy that included emtricitabine/tenofovir disoproxil fumarate or abacavir/lamivudine administered with atazanavir/ritonavir, darunavir/ritonavir, lopinavir/ritonavir, rilpivirine, raltegravir or elvitegravir/cobicistat.

Of the 106 treated subjects, the median age was 57 years (range: 25 to 72); 86% of the subjects were male; 51% were White; 45% were Black; 22% had a baseline body mass index at least 30 kg/m²; the proportions of patients with genotype 1, 2, 3, or 4 HCV infection were 74%, 10%, 11%, and 5%, respectively; no subjects with genotype 5 or 6 HCV were treated with EPCLUSA; 77% had non-CC IL28B alleles (CT or TT); 74% had baseline HCV RNA levels of at least 800,000 IU/mL; 18% had compensated cirrhosis; and 29% were treatment experienced. The overall mean CD4+ count was 598 cells/μL (range: 183–1513 cells/μL) and 57% of subjects had CD4+ counts > 500 cells/μL.

Table 17 presents the SVR12 for the ASTRAL-5 trial by HCV genotype.

Table 17 Study ASTRAL-5: Virologic Outcomes by HCV Genotype in Subjects Coinfected with HIV-1 without Cirrhosis or with Compensated Cirrhosis (12 Weeks After Treatment)

	EPCLUSA 12 Weeks (N=106)						
	Total (all GTs) (N=106)	GT-1			GT-2 (N=11)	GT-3 (N=12)	GT-4 (N=5)
		GT-1a (N=66)	GT-1b (N=12)	Total (N=78)			
SVR12	95% (101/106)	95% (63/66)	92% (11/12)	95% (74/78)	100% (11/11)	92% (11/12)	100% (5/5)
Outcome for Subjects without SVR							
On-Treatment Virologic Failure	0/106	0/66	0/12	0/78	0/11	0/12	0/5
Relapse ^a	2% (2/103)	3% (2/65)	0/11	3% (2/76)	0/11	0/11	0/5
Other ^b	3% (3/106)	2% (1/66)	8% (1/12)	3% (2/78)	0/11	8% (1/12)	(0/5)

a. The denominator for relapse is the number of subjects with HCV RNA <LLOQ at their last on-treatment assessment.

b. Other includes subjects who did not achieve SVR and did not meet virologic failure criteria.

No subject had HIV-1 rebound during treatment and CD4+ counts were stable during treatment.

14.4 Clinical Trials in Subjects with Decompensated Cirrhosis

ASTRAL-4 was a randomized, open-label trial in subjects with genotype 1, 2, 3, 4, 5, or 6 HCV infection and Child-Pugh B cirrhosis at screening. Subjects were randomized in a 1:1:1 ratio to treatment with EPCLUSA for 12 weeks (N=90), EPCLUSA with ribavirin for 12 weeks (N=87), or EPCLUSA for 24 weeks (N=90). Randomization was stratified by HCV genotype (1, 2, 3, 4, 5, 6, and indeterminate).

Demographics and baseline characteristics were balanced across the treatment groups. Of the 267 treated subjects, the median age was 59 years (range: 40 to 73); 70% of the subjects were male; 90% were White; 6% were Black; 42% had a baseline body mass index at least 30 kg/m². The proportions of subjects with genotype 1, 2, 3, 4, or 6 HCV were 78%, 4%, 15%, 3%, and less than 1% (1 subject), respectively. No subjects with genotype 5 HCV infection were enrolled. 76% had non-CC IL28B alleles (CT or TT); 56% had baseline HCV RNA levels at least 800,000 IU/mL; 55% were treatment-experienced; and 95% of subjects had Model for End Stage Liver Disease (MELD) score less than or equal to 15 at baseline. Although all subjects had Child-Pugh B cirrhosis at screening, 6% and 4% of subjects were assessed to have Child-Pugh A and Child-Pugh C cirrhosis, respectively, on the first day of treatment.

Treatment with EPCLUSA with ribavirin for 12 weeks resulted in numerically higher SVR12 rates than treatment with EPCLUSA for 12 weeks or 24 weeks. Because EPCLUSA with ribavirin for 12 weeks is the recommended dosage regimen, the results of the 12- and 24-week EPCLUSA treatment groups are not presented.

Table 18 presents the SVR12 for subjects treated with EPCLUSA with ribavirin for 12 weeks in the ASTRAL-4 trial by HCV genotype. No subjects with genotype 5 or 6 HCV were treated with EPCLUSA with ribavirin for 12 weeks.

Table 18 Study ASTRAL-4: Virologic Outcomes in Subjects with Decompensated Cirrhosis After 12 Weeks of Treatment by HCV Genotype

	EPCLUSA + RBV 12 Weeks (N=87)	
	SVR12	Virologic Failure (relapse and on-treatment failure)
Overall SVR12 ^a	94% (82/87)	3% (3/87)
Genotype 1	96% (65/68)	1% (1/68) ^b
Genotype 1a	94% (51/54)	2% (1/54) ^b
Genotype 1b	100% (14/14)	0% (0/14)
Genotype 3	85% (11/13)	15% (2/13) ^c

RBV = ribavirin.

a. Includes subjects with baseline CPT C cirrhosis: all 4 subjects achieved SVR12.

b. This subject with genotype 1a experienced relapse.

c. One subject had on-treatment virologic failure; pharmacokinetic data from this subject was consistent with non-adherence.

All subjects with genotype 2 (N=4) and genotype 4 (N=2) HCV infection treated with EPCLUSA and ribavirin achieved SVR12.

14.5 Clinical Trial in Adult Liver Transplant Recipients without Cirrhosis and with Compensated Cirrhosis

Trial 2104 was an open-label clinical trial that evaluated 12 weeks of treatment with EPCLUSA in 79 HCV-infected treatment-naïve and previously treated adult subjects who had undergone liver transplantation. The proportions of subjects with genotype 1, 2, 3, or 4 HCV infection were 47%, 4%, 44%, and 5%, respectively. The median age was 62 years (range: 45 to 81); 81% were male; 82% were White; 3% were Black; and 15% were Asian; 28% had a baseline body mass index at least 30 kg/m². At baseline, 18% had compensated cirrhosis, and 60% were treatment experienced (subjects with prior exposure to any HCV NS5A inhibitor were excluded). Immunosuppressants allowed for coadministration were tacrolimus, mycophenolate mofetil, cyclosporine, and azathioprine. The overall SVR12 rate was 96% (76/79). Of the subjects completing 12 weeks of EPCLUSA, 2 subjects experienced virologic relapse.

14.6 Clinical Trial in Subjects with Severe Renal Impairment Requiring Dialysis

Trial 4062 was an open-label clinical trial that evaluated 12 weeks of treatment with EPCLUSA in 59 HCV-infected adults with ESRD requiring dialysis. The proportions of subjects with genotype 1, 2, 3, 4, 6 or indeterminate HCV infection were 42%, 12%, 27%, 7%, 3%, and 8%, respectively. At baseline, 29% of subjects had cirrhosis, 22% were treatment-experienced (subjects with prior exposure to any HCV NS5A inhibitor were excluded), 92% were on hemodialysis, and 8% were on peritoneal dialysis; mean duration on dialysis was 7 years (range: 0 to 40 years). The overall SVR rate was 95% (56/59). Of the subjects completing 12 weeks of EPCLUSA, 1 subject experienced virologic relapse.

14.7 Clinical Trial in Pediatric Subjects

The efficacy of EPCLUSA once daily for 12 weeks was evaluated in an open-label trial (Study 1143) in 214 genotype 1, 2, 3, 4, or 6 HCV treatment-naïve (N=188) or treatment-experienced (N=26) pediatric subjects 3 years of age and older without cirrhosis or with compensated cirrhosis.

Subjects 12 Years to <18 Years of Age: EPCLUSA was evaluated in 102 subjects 12 years to <18 years of age with genotype 1, 2, 3, 4, or 6 HCV infection. Among these subjects, 80 (78%) were treatment-naïve and 22 (22%) were treatment-experienced. The median age was 15 years (range: 12 to 17); 51% of the subjects were female; 73% were White, 9% were Black, and 11% were Asian; 14% were Hispanic/Latino; mean body mass index was 23 kg/m² (range: 13 to 49 kg/m²); mean weight was 61 kg (range: 22 to 147 kg); 58% had baseline HCV RNA levels greater than or equal to 800,000 IU/mL; the proportions of subjects with genotype 1, 2, 3, 4, or 6 HCV infection were 74%, 6%, 12%, 2%, and 6%, respectively; no subjects had known cirrhosis. The majority of subjects (89%) had been infected through vertical transmission.

The SVR rate was 93% (71/76) in subjects with genotype 1 HCV infection and 100% in subjects with genotype 2 (6/6), genotype 3 (12/12), genotype 4 (2/2), and genotype 6 (6/6) HCV infection. One subject discontinued treatment at Week 4 and subsequently relapsed; the other four subjects who did not achieve SVR12 did not meet virologic failure criteria (lost to follow-up).

Subjects 6 Years to <12 Years of Age: EPCLUSA was evaluated in 71 subjects 6 years to <12 years of age with genotype 1, 2, 3, or 4 HCV infection. Among these subjects, 67 (94%) were treatment-naïve and 4 (6%) were treatment-experienced. The median age was 8 years (range: 6 to 11); 54% of the subjects were female; 90% were White, 6% were Black, and 1% were Asian; 10% were Hispanic/Latino; mean body mass index was 17 kg/m² (range: 13 to 31 kg/m²); mean weight was 30 kg (range: 18 to 78 kg); 48% had baseline HCV RNA levels greater than or equal to 800,000 IU per mL; the proportions of subjects with genotype 1, 2, 3, or 4 HCV infection were 76%, 3%, 15%, and 6%, respectively; no subjects had known cirrhosis. The majority of subjects (94%) had been infected through vertical transmission.

The SVR rate was 93% (50/54) in subjects with genotype 1 HCV infection, 91% (10/11) in subjects with genotype 3 HCV infection, and 100% in subjects with genotype 2 (2/2) and genotype 4 (4/4) HCV infection. One subject had on-treatment virologic failure; the other four subjects who did not achieve SVR12 did not meet virologic failure criteria (lost to follow-up).

Subjects 3 Years to <6 Years of Age: EPCLUSA was evaluated in 41 treatment-naïve subjects 3 years to <6 years of age with genotype 1, 2, 3, or 4 HCV infection. The median age was 4 years (range: 3 to 5); 59% of the subjects were female; 78% were White, 7% were Black; 10% were Hispanic/Latino; mean body mass index was 17.0 kg/m² (range: 13.9 to 22.0 kg/m²); mean weight was 19 kg (range: 13 to 35 kg); 49% had baseline HCV RNA levels greater than or equal to 800,000 IU per mL; the proportions of subjects with genotype 1, 2, 3, or 4 HCV infection were 78%, 15%, 5%, and 2%, respectively; no subjects had known cirrhosis. The majority of subjects (98%) had been infected through vertical transmission.

The SVR12 rate among all subjects was 83% (34/41); with 88% (28/32) in subjects with genotype 1 HCV infection, 50% (3/6) in subjects with genotype 2 HCV infection, and 100% in subjects with genotype 3 (2/2) and genotype 4 (1/1) HCV infection. None of the 34 subjects who completed the treatment had virologic failure. Of the remaining seven subjects who did not achieve SVR12, five discontinued treatment on Day 1, one on Day 7, and one on Day 20 [see *Adverse Reactions (6.1)*].

16 HOW SUPPLIED/STORAGE AND HANDLING

Tablets

EPCLUSA tablets, 400 mg/100 mg, are pink, diamond-shaped, film-coated, debossed with “GSI” on one side and “7916” on the other. Each bottle contains 28 tablets (NDC 61958-2201-1), polyester coil, and is closed with a child-resistant closure.

EPCLUSA tablets, 200 mg/50 mg, are pink, oval-shaped, film-coated, debossed with “GSI” on one side and “S/V” on the other. Each bottle contains 28 tablets (NDC 61958-2203-1), polyester coil, and is closed with a child-resistant closure.

- Store below 30 °C (86 °F).
- Dispense only in original container.

Oral Pellets

EPCLUSA oral pellets, 200 mg/50 mg, are white to off-white, film-coated pellets supplied as unit-dose packets in cartons. Each carton contains 28 packets (NDC 61958-2204-1).

EPCLUSA oral pellets, 150 mg/37.5 mg, are white to off-white, film-coated pellets supplied as unit-dose packets in cartons. Each carton contains 28 packets (NDC 61958-2205-1).

- Store below 30 °C (86 °F).
- Do not use if carton tamper-evident seal or packet has been opened or damaged.

17 PATIENT COUNSELING INFORMATION

Advise the patient to read the FDA-approved patient labeling (Patient Information and Instructions for Use).

Risk of Hepatitis B Virus Reactivation in Patients Coinfected with HCV and HBV

Inform patients that HBV reactivation can occur in patients coinfecting with HBV during or after treatment of HCV infection. Advise patients to tell their healthcare provider if they have a history of HBV infection [see *Warnings and Precautions (5.1)*].

Serious Symptomatic Bradycardia When Coadministered with Amiodarone

Advise patients to seek medical evaluation immediately for symptoms of bradycardia such as near-fainting or fainting, dizziness or lightheadedness, malaise, weakness, excessive tiredness, shortness of breath, chest pain, confusion, or memory problems [see *Warnings and Precautions (5.2)*, *Adverse Reactions (6.2)*, and *Drug Interactions (7.3)*].

Drug Interactions

Inform patients that EPCLUSA may interact with other drugs. Advise patients to report to their healthcare provider the use of any other prescription or nonprescription medication or herbal products including St. John's wort [see *Warnings and Precautions (5.2, 5.3) and Drug Interactions (7)*].

Administration

Advise patients to take EPCLUSA once daily on a regular dosing schedule with or without food. Inform patients that it is important not to miss or skip doses and to take EPCLUSA for the duration that is recommended by the physician.

For EPCLUSA oral pellets, advise patients or caregivers to read and follow the Instructions for Use for preparing the correct dose [see *Dosage and Administration (2.4, 2.5)*].

Pregnancy

Advise patients to avoid pregnancy during combination treatment with EPCLUSA and ribavirin and for 6 months after completion of treatment. Inform patients to notify their healthcare provider immediately in the event of a pregnancy [see *Use in Specific Populations (8.1)*].

Manufactured and distributed by:
Gilead Sciences, Inc.
Foster City, CA 94404

EPCLUSA, ATRIPLA, COMPLERA, GENVOYA, HARVONI, and STRIBILD are trademarks of Gilead Sciences, Inc., or its related companies. All other trademarks referenced herein are the property of their respective owners.

© 2021 Gilead Sciences, Inc. All rights reserved.
208341-GS-009

PATIENT INFORMATION

EPCLUSA® (ep-KLOO-suh)
(sofosbuvir and velpatasvir)
tablets

EPCLUSA® (ep-KLOO-suh)
(sofosbuvir and velpatasvir)
oral pellets

Important: If you take EPCLUSA with ribavirin, you should also read the Medication Guide for ribavirin.

What is the most important information I should know about EPCLUSA?

EPCLUSA can cause serious side effects, including:

Hepatitis B virus reactivation: Before starting treatment with EPCLUSA, your healthcare provider will do blood tests to check for hepatitis B virus infection. If you have ever had hepatitis B virus infection, the hepatitis B virus could become active again during or after treatment of hepatitis C virus with EPCLUSA. Hepatitis B virus becoming active again (called reactivation) may cause serious liver problems including liver failure and death. Your healthcare provider will monitor you if you are at risk for hepatitis B virus reactivation during treatment and after you stop taking EPCLUSA.

For more information about side effects, see the section “What are the possible side effects of EPCLUSA?”

What is EPCLUSA?

EPCLUSA is a prescription medicine used to treat adults and children 3 years of age and older with chronic (lasting a long time) hepatitis C virus (HCV) genotype 1, 2, 3, 4, 5, or 6 infection:

- without cirrhosis or with compensated cirrhosis.
- with advanced cirrhosis (decompensated) in combination with ribavirin.

EPCLUSA contains the two medicines: sofosbuvir and velpatasvir.

It is not known if EPCLUSA is safe and effective in children under 3 years of age.

Before taking EPCLUSA, tell your healthcare provider about all of your medical conditions, including if you:

- have ever had hepatitis B virus infection
- have liver problems other than hepatitis C infection
- have had a liver transplant
- have kidney problems or you are on dialysis
- have HIV-1 infection
- are pregnant or plan to become pregnant. It is not known if EPCLUSA will harm your unborn baby.
 - Females who take EPCLUSA in combination with ribavirin should avoid becoming pregnant during treatment and for 6 months after stopping treatment. Call your healthcare provider right away if you think you may be pregnant or become pregnant during treatment with EPCLUSA in combination with ribavirin.
 - **Males and females who take EPCLUSA in combination with ribavirin should also read the ribavirin Medication Guide for important pregnancy, contraception, and infertility information.**
- are breastfeeding or plan to breastfeed. It is not known if EPCLUSA passes into your breast milk.
 - Talk to your healthcare provider about the best way to feed your baby during treatment with EPCLUSA.

Tell your healthcare provider about all of the medicines you take, including prescription and over-the-counter medicines, vitamins, and herbal supplements. EPCLUSA and other medicines may affect each other. This can cause you to have too much or not enough EPCLUSA or other medicines in your body. This may affect the way EPCLUSA or your other medicines work or may cause side effects.

Keep a list of your medicines to show your healthcare provider and pharmacist.

- You can ask your healthcare provider or pharmacist for a list of medicines that interact with EPCLUSA.
- **Do not start taking a new medicine without telling your healthcare provider.** Your healthcare provider can tell you if it is safe to take EPCLUSA with other medicines.

How should I take EPCLUSA?

- Take EPCLUSA exactly as your healthcare provider tells you to take it. Do not change your dose unless your healthcare provider tells you to.
- Do not stop taking EPCLUSA without first talking with your healthcare provider.
- Take EPCLUSA oral pellets or tablets by mouth, with or without food.
- For adults the usual dose of EPCLUSA is one 400/100 mg tablet each day.
- For children 3 years of age and older your healthcare provider will prescribe the right dose of EPCLUSA oral pellets or tablets based on your child's body weight.
 - Tell your healthcare provider if your child has problems with swallowing tablets.
 - If your healthcare provider prescribes EPCLUSA oral pellets for your child, see “How should I give EPCLUSA oral pellets to my child?”

- Do not miss a dose of EPCLUSA. Missing a dose lowers the amount of medicine in your blood. Refill your EPCLUSA prescription before you run out of medicine.
- If you take too much EPCLUSA, call your healthcare provider or go to the nearest hospital emergency room right away.

How should I give EPCLUSA oral pellets to my child?

See the detailed Instructions for Use for information about how to give or take a dose of EPCLUSA oral pellets.

- Administer EPCLUSA oral pellets exactly as instructed by your healthcare provider.
- EPCLUSA oral pellets can be taken with food or directly in the mouth.
- For children younger than 6 years, take EPCLUSA oral pellets with food.
- EPCLUSA oral pellets should be swallowed whole. Do not chew EPCLUSA oral pellets to avoid a bitter after taste.
- Do not open the EPCLUSA oral pellets packet until ready to use.

What are the possible side effects of EPCLUSA?

EPCLUSA can cause serious side effects, including:

- **Hepatitis B virus reactivation.** See “What is the most important information I should know about EPCLUSA?”
- **Slow heart rate (bradycardia).** EPCLUSA treatment may result in slowing of the heart rate along with other symptoms when taken with amiodarone (Cordarone[®], Nexterone[®], Pacerone[®]), a medicine used to treat certain heart problems. In some cases bradycardia has led to death or the need for a heart pacemaker when amiodarone is taken with medicines similar to EPCLUSA that contain sofosbuvir. Get medical help right away if you take amiodarone with EPCLUSA and get any of the following symptoms:
 - fainting or near-fainting
 - dizziness or lightheadedness
 - not feeling well
 - weakness
 - extreme tiredness
 - shortness of breath
 - chest pains
 - confusion
 - memory problems
- The most common side effects of EPCLUSA in adults and children 6 years of age and older include headache and tiredness.
- The most common side effects of EPCLUSA when used with ribavirin in adults with decompensated cirrhosis are tiredness, low red blood cells, nausea, headache, trouble sleeping, and diarrhea.
- The most common side effects of EPCLUSA in children younger than 6 years of age are vomiting and problems with spitting up the medicine.

These are not all the possible side effects of EPCLUSA.

Call your doctor for medical advice about side effects. You may report side effects to FDA at 1-800-FDA-1088.

How should I store EPCLUSA?

- Store EPCLUSA tablets or oral pellets below 86°F (30°C).
- Keep EPCLUSA tablets in the original container.
- Do not use EPCLUSA oral pellets if the carton tamper-evident seal or the packet has been opened or damaged.

Keep EPCLUSA and all medicines out of the reach of children.

General information about the safe and effective use of EPCLUSA

Medicines are sometimes prescribed for purposes other than those listed in a Patient Information leaflet. Do not use EPCLUSA for a condition for which it was not prescribed. Do not give EPCLUSA to other people, even if they have the same symptoms you have. It may harm them.

You can ask your healthcare provider or pharmacist for information about EPCLUSA that is written for health professionals.

What are the ingredients in EPCLUSA?

Active ingredients: sofosbuvir and velpatasvir

Inactive ingredients, Tablets: copovidone, croscarmellose sodium, magnesium stearate, and microcrystalline cellulose.

The tablet film-coat contains: iron oxide red, polyethylene glycol, polyvinyl alcohol, talc, and titanium dioxide.

Inactive ingredients, Oral Pellets: colloidal silicon dioxide, copovidone, croscarmellose sodium, lactose monohydrate, magnesium stearate, and microcrystalline cellulose.

The oral pellets film-coat contains: amino methacrylate copolymer, colloidal silicon dioxide, hypromellose, *L*-tartaric acid, polyethylene glycol, stearic acid, talc, and titanium dioxide.

Manufactured and distributed by:

Gilead Sciences, Inc., Foster City, CA 94404

EPCLUSA is a trademark of Gilead Sciences, Inc., or its related companies. All other trademarks referenced herein are the property of their respective owners.

©2021 Gilead Sciences, Inc. All rights reserved.

For more information, call 1-800-445-3235 or go to www.epclusa.com.

208341-GS-009

INSTRUCTIONS FOR USE
EPCLUSA® (ep-KLOO-suh)
(sofosbuvir and velpatasvir)
pellets, for oral use

Read the Patient Information that comes with EPCLUSA oral pellets for important information about EPCLUSA.

This Instructions for Use contains information on how to take EPCLUSA oral pellets. Be sure you understand and follow the instructions. If you have any questions, ask your healthcare provider or pharmacist.

Important Information You Need to Know Before Taking EPCLUSA oral pellets

- **For oral use only** (take by mouth with or without food).
- Pellets should be swallowed whole. **Do not** chew pellets.
- **Do not** open the EPCLUSA oral pellet packet(s) until ready to use.
- For children younger than 6 years, take EPCLUSA oral pellets with food.
- EPCLUSA oral pellets are white to off-white pellets supplied as single-use packets in cartons. Each carton contains 28 packets.
- **Do not** use EPCLUSA oral pellets if the carton tamper-evident seal or the packet has been opened or damaged.

Gather Supplies:

Before you prepare a dose of EPCLUSA oral pellets, gather the following supplies:

- Daily EPCLUSA oral pellet packet(s), as prescribed by your healthcare provider
- Scissors (optional)

If taking EPCLUSA oral pellets with food, gather the following additional supplies:

- One or more spoonfuls of non-acidic soft food such as pudding, chocolate syrup, or ice cream
- Bowl
- Spoon

Prepare and Administer a Dose:

Step 1: If taking EPCLUSA oral pellets with food, add one or more spoonfuls of non-acidic soft food to the bowl first.

Step 2: Hold the EPCLUSA oral pellets packet with the cut line on top (see **Figure A**).

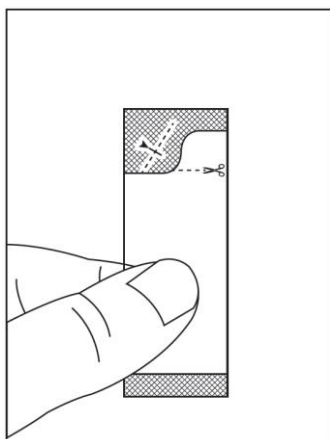

Figure A

Step 3: Shake the packet gently to settle the pellets to the bottom of the packet (see **Figure B**).

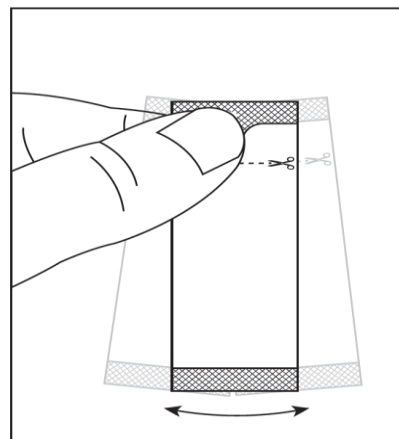

Figure B

Step 4: Cut the packet along the cut line with scissors (see **Figure C**), or fold the packet back at the tear line (see **Figure D**) and tear open (see **Figure E**).

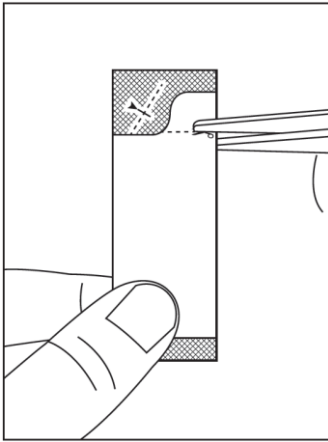

Figure C

OR

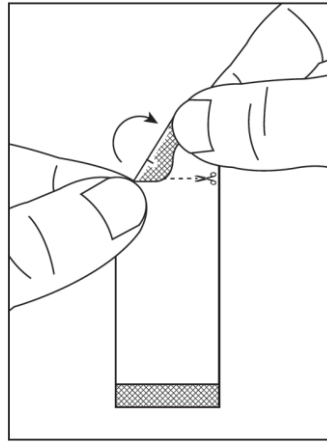

Figure D

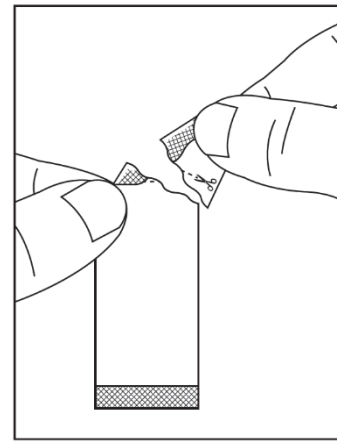

Figure E

Step 5:

- If taking **EPCLUSA oral pellets with food**, carefully pour the **entire contents** of the prescribed number of EPCLUSA oral pellet packet(s) onto the food in the bowl and gently mix with a spoon (see **Figure F**). Take the EPCLUSA oral pellets and food mixture **within 15 minutes** without chewing to avoid a bitter taste.
- If taking **EPCLUSA oral pellets by mouth**, pour the **entire contents** of the prescribed number of EPCLUSA oral pellet packet(s) directly in the mouth and swallow without chewing to avoid a bitter taste (see **Figure G**). Water may be taken after swallowing the pellets, if needed.

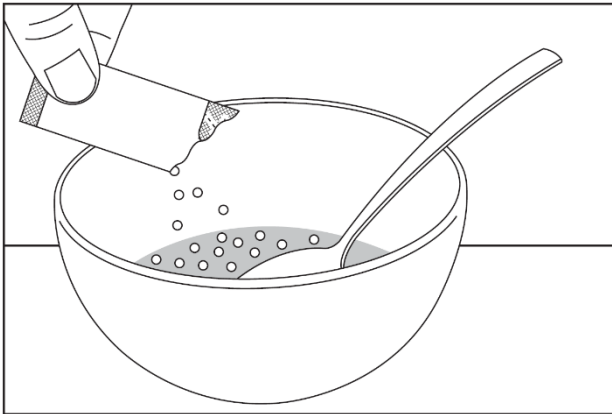

Figure F

OR

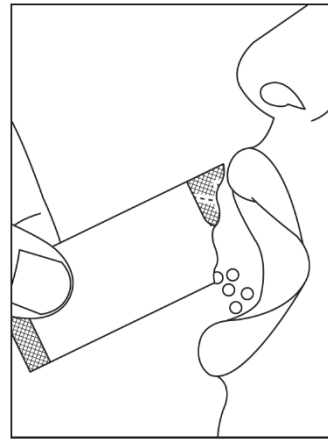

Figure G

Step 6: Make sure all of the EPCLUSA oral pellets are taken. Make sure that no EPCLUSA oral pellets remain in the packet(s) or in the food.

Storing EPCLUSA oral pellets

- Store EPCLUSA pellets below 86°F (30°C).
- **Keep EPCLUSA oral pellets and all medicines out of the reach of children.**

Disposing of EPCLUSA oral pellets

- Throw away (dispose of) any unused portion. Do not store and reuse any leftover EPCLUSA oral pellets or EPCLUSA mixture (oral pellets mixed with food).

For more information, call 1-800-445-3235 or go to www.EPCLUSA.com.

Manufactured for and distributed by: Gilead Sciences, Inc., Foster City, CA 94404

EPCLUSA is a trademark of Gilead Sciences, Inc., or its related companies.

© 2021 Gilead Sciences, Inc. All rights reserved.

208341-GS-009

This Instructions for Use has been approved by the U.S. Food and Drug Administration.

Issued: June 2021